



OUTDOOR & SPORTS
HOME & LIFE
PRODUCT CATALOG

POWERUP



POWERUP
ON WEB



VENTURE **OUT**



ENJOY **LONGER**



CREATE **MEMORIES**



READY AND ABLE

Ledlenser is a reliable and trusted companion, providing high-quality portable light allowing individuals to be ready and able in the darkest of work, home or outdoor situations. Anytime there is a need for additional light or no other light source is available, Ledlenser is there, empowering one to be prepared to solve problems, secure and safe in the unknown or free to go further and explore.

CONTENT CLICKABLE ↓

CONTENT

OUTDOOR & SPORTS

HOME & LIFE

- 2-3 **CONTENT**
- 4-9 **NEW PRODUCTS**
 - 9 HF4R Core **NEW**
 - 9 HF6R Core **NEW**
 - 9 HF8R Core **NEW**
- 10-25 **FLASHLIGHTS**
 - 12 P2R Core
 - 12 P3 Core
 - 13 P4 Core
 - 13 P4R Core
 - 14 P5 Core
 - 14 P5R Core
 - 15 P6 Core
 - 15 P6R Core
 - 19 P7 Core
 - 19 P7R Core
 - 19 P17R Core
 - 20 P6R Core QC
 - 24 P6R Signature
 - 24 P7R Signature
 - 25 P18R Signature
- 26-29 **KEYRING LAMPS**
 - 28 K4R
 - 29 K6R
 - 29 K6R Safety
- 30-35 **KIDSLIGHTS**
 - 33 KIDLED2
 - 33 KIDLED4R
 - 34 KIDBEAM4
 - 34 KIDCAMP6
- 36-41 **X-SERIES**
 - 39 XP30R **NEW**
 - 40 X21R

- 42-55 **HEADLAMPS**
 - 46 H5 Core
 - 46 H5R Core
 - 47 H7R Core
 - 47 H15R Core
 - 47 H19R Core
 - 51 H7R Signature
 - 51 H19R Signature
 - 54 NEO1R
 - 55 NEO3
 - 55 NEO5R
 - 55 NEO9R
- 56-57 **CLIPLIGHT**
 - 57 CU2R
- 58-63 **LANTERNS**
 - 62 ML4
 - 62 ML4 WL
 - 63 ML6
 - 63 ML6 WL
 - 63 ML6 WL Connect
- 64-69 **PORTABLE ENERGY**
 - 66 FLEX5
 - 66 FLEX10
 - 68 FLEX3
 - 68 FLEX7
- 70-73 **ACCESSORIES**
- 76-79 **TECHNOLOGIES**
- 80-81 **ABOUT US**
- 82-83 **WARRANTY + ISO**
- 84-85 **NOTES + CONTACT**



RETURN TO THE MENU QUICKLY FROM ANY PAGE

— NOVELTIES THE HF-SERIES



 LEDLENSER

NEW
REVOLUTIONARY
TECHNOLOGIES



HF8R CORE

REVOLUTIONARY TECHNOLOGIES FOR MAXIMUM FLEXIBILITY:

With the HF8R, Ledlenser introduces its first hands-free headlamp. Why break your flow at work when your headlamp will adjust automatically or transition seamlessly, while providing you with the perfect light pattern. Without a battery box at the back of your head or an additional cable at the headband, you will be more comfortable and move more freely.

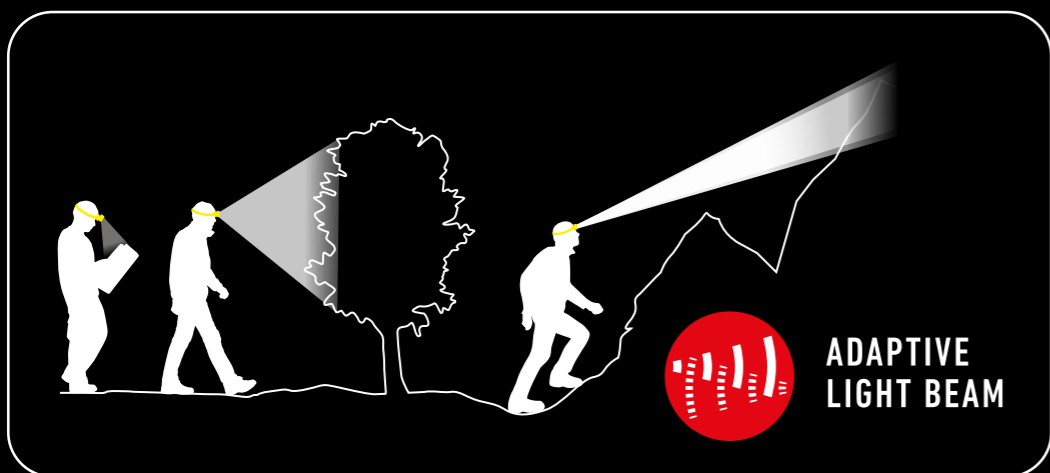

TRULY HANDS-FREE DIMS AND FOCUSES AUTOMATICALLY



☀️ 1600 lm¹
➡️ 210 m¹
🕒 90 h¹

- 01** – Powerful headlamp with additional red front light
- 02** – Automatic dimming and focusing thanks to our **Adaptive Light Beam Technology** – the system detects reflections and lighting conditions and automatically controls all light sources separately. This allows the HF8R to be used completely hands-free.
- 03** – Powerful battery can easily be recharged via **Magnetic Charge System**
- 04** – Water and dustproof (IP68)
- 05** – Large scope of delivery for versatile options and use
- 06** – Lamp head tilts **steplessly**
- 07** – Perfect light pattern for any range and virtually seamless focusing thanks to our **Digital Advanced Focus System**; optional manual operation via **Focus Wheel**
- 08** – High-quality **aluminum housing**
- 09** – Remote control via **Ledlenser Connect App** (upgrade with additional features available)



HF-SERIES NEW

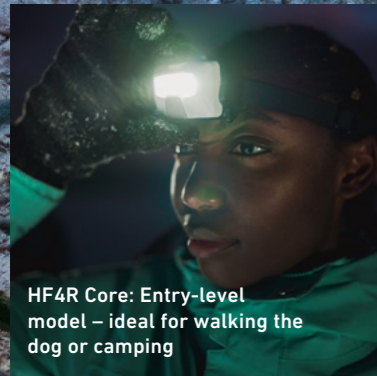

HF4R Core: Entry-level model – ideal for walking the dog or camping

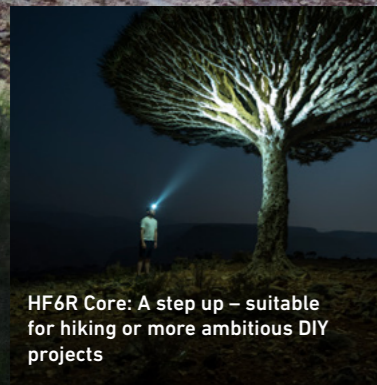

HF6R Core: A step up – suitable for hiking or more ambitious DIY projects

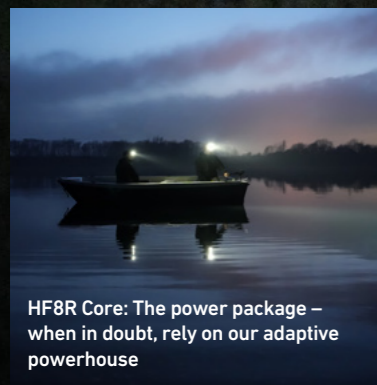

HF8R Core: The power package – when in doubt, rely on our adaptive powerhouse



LED

LED Configuration

Light Functions

Luminous Flux¹ (lm)

Beam Distance¹ (m)

Run Time¹ (h)

Color Temperature (K)

Color Rendering Index (CRI)

BATTERY AND CASE

Battery

Battery Capacity² (Wh / mAh)

IP Level

Rechargeable

Charging Time⁵ (min)

Drop Height (m)

WEIGHT

Weight incl. Battery (g / oz)

TECHNOLOGIE

Adaptive Light Beam

Digital Advanced Focus System

Magnetic Charge System

Temperature Control System

Cooling Technology

More Features

PACKAGING

Item no. Box / GTIN

Item no. Box / GTIN

Item no. Box / GTIN

Content Box

Optional accessories on page 72



HF4R CORE



2x High Power LED, 1x Red LED

Boost / Power / Mid Power / Low Power (+ Red Light)

500 / 300 / 120 / 20

130 / 100 / 60 / 15

- / 2.5 / 5 / 35

5200 – 6200

70

1x Li-ion Battery Pack 3.7V

3.7 / 1000

IP68

Yes

180

2

72 / 2.54

Adaptive Light Beam

Digital Advanced Focus System

Magnetic Charge System

Temperature Control System

Cooling Technology

Fusion Beam, Transportation Lock, Memory Function, Backup Mode, Battery Indicator, Charge Indicator, Low Battery Warning

● Black: 502790 / 4058205031684

● Blue: 502791 / 4058205031707

● Red: 502792 / 4058205031738

○ White: 502797 / 4058205031851

Connect Adapter, Magnetic Charging Cable (USB-C)



HF6R CORE



2x Xtreme LED, 1x High Power LED, 1x Red LED

Boost / Power / Mid Power / Low Power (+ Red Light)

800 / 500 / 250 / 20

160 / 140 / 80 / 25

- / 3 / 6 / 60

5200 – 6200

70

1x Li-ion Battery Pack 3.7V

7.4 / 2000

IP68

Yes

225

2

126 / 4.44

Adaptive Light Beam

Digital Advanced Focus System

Magnetic Charge System

Temperature Control System

Cooling Technology

Memory Function, Transportation Lock, Backup Mode, Aluminum housing, Battery Indicator, Charge Indicator, Low Battery Warning

● Black: 502796 / 4058205031837

● Blue: 502966 / 4058205034319

● Red: 502967 / 4058205034340

○ White: 502797 / 4058205031851

Comfort Pad, Connect Adapter, Magnetic Charging Cable (USB-C)



HF8R CORE



3x Xtreme LED, 1x High Power LED, 1x Red LED

Boost / Power / Mid Power / Low Power (+ Red Light) (+S.O.S., Alpine distress signal via App)

1600 / 900 / 300 / 20

210 / 200 / 100 / 25

- / 3.5 / 10 / 90

5200 – 6200

70

1x Li-ion Battery Pack 3.7V

13.7 / 3700

IP68

Yes

270

2

194 / 6.84

Adaptive Light Beam

Digital Advanced Focus System

Magnetic Charge System

Temperature Control System

Cooling Technology

Bluetooth®, Transportation Lock, Memory Function, Backup Mode, Aluminum housing, Emergency Light, Battery Indicator, Charge Indicator, Low Battery Warning

● Black: 502801 / 4058205031943

● Blue: 502802 / 4058205031944

● Red: 502803 / 4058205031945

○ White: 502804 / 4058205031946

Comfort Pad, Connect Adapter, Magnetic Charging Cable (USB-C), removable Overhead Strap

¹⁻⁸ Information on page 84



FLASHLIGHTS



 LEDLENSER



P-SERIES CORE



reddot winner 2021



P2R CORE



P3 CORE

LED		
LED Configuration	1x Power LED	1x Power LED
Light Functions	Power / Mid Power / Low Power	Power / Mid Power / Low Power
Luminous Flux ¹ (lm)	120 / 50 / 15	90 / 50 / 15
Beam Distance ¹ (m)	65 / 45 / 15	110 / 70 / 40
Run Time ¹ (h)	0.5 / 1 / 5	3 / 4 / 6
Color Temperature (K)	6000 - 7500	6000 - 7500
Color Rendering Index (CRI)	70	70
BATTERY AND CASE		
Battery	1x Li-ion Battery 3.7V mit Micro-USB	1x Micro (AAA) Alkaline 1.5V
Battery Capacity ² (Wh / mAh)	0.74 / 200	
IP Level	IP54	IP54
Rechargeable	Yes	No
Charging Time ⁵ (min)	150	
Drop Height (m)	2	2
SIZE AND WEIGHT		
Length – Defocused (mm)	103	96
Head Diameter (mm)	15	20
Weight incl. Battery (g / oz)	36 / 1.3	42 / 1.5
TECHNOLOGIE		
Smart Light Technology		
Flex Sealing Technology		
Magnetic Charge System		
Temperature Control		
Advanced Focus System	●	●
More Features	Energy Saving	Rapid Focus
PACKAGING		
Item no. Box / GTIN	502176 / 4058205020367	502597 / 4058205028462
Content Box	1 Battery Set, Pocket Clip, Micro-USB Charging Cable	1 Battery Set, Pocket Clip
OPTIONAL ACCESSORIES		
	502248 Lamp Adapter Type A	0337 Pouch Type D
	0337 Pouch Type D	502248 Lamp Adapter Type A
Further accessories on page 70	0380 USB Car Charger	



P4 CORE



P4R CORE



LED	
LED Configuration	1x Power LED
Light Functions	Power / Mid Power / Low Power
Luminous Flux ¹ (lm)	120 / 60 / 15
Beam Distance ¹ (m)	90 / 55 / 25
Run Time ¹ (h)	5 / 9 / 20
Color Temperature (K)	6000 - 7500
Color Rendering Index (CRI)	70
BATTERY AND CASE	
Battery	2x Micro (AAA) Alkaline 1.5V
Battery Capacity ² (Wh / mAh)	2.22 / 600
IP Level	IP54
Rechargeable	No
Charging Time ⁵ (min)	150
Drop Height (m)	2
SIZE AND WEIGHT	
Length – Defocused (mm)	146
Head Diameter (mm)	15
Weight incl. Battery (g / oz)	58 / 2.0
TECHNOLOGIE	
Smart Light Technology	
Flex Sealing Technology	
Magnetic Charge System	
Temperature Control	
Advanced Focus System	●
More Features	Energy Saving
PACKAGING	
Item no. Box / GTIN	502598 / 4058205028493
Content Box	1 Battery Set, Pocket Clip
OPTIONAL ACCESSORIES	
	502248 Lamp Adapter Type A
	0380 USB Car Charger
	502271 USB Adapter



P-SERIES CORE



reddot winner 2021



reddot winner 2021



P5 CORE



P5R CORE



LED		
LED Configuration	1x High Power LED	1x High Power LED
Light Functions	Power / Mid Power / Low Power	Boost / Power / Mid Power / Low Power (+ Position, Blink, S.O.S., Strobe)
Luminous Flux ¹ (lm)	150 / 60 / 15	500 / 350 / 130 / 15
Beam Distance ¹ (m)	90 / 60 / 30	250 / 180 / 110 / 40
Run Time ¹ (h)	2.5 / 5 / 12	- / 1 / 3.5 / 25
Color Temperature (K)	6000 - 7500	6000 - 7500
Color Rendering Index (CRI)	70	70

BATTERY AND CASE		
Battery	1x Mignon (AA) Alkaline 1.5V	1x 14500 Li-ion Battery 3.7V
Battery Capacity ² (Wh / mAh)		2.77 / 750
IP Level	IP44	IP68
Rechargeable	No	Yes
Charging Time ⁵ (min)		120
Drop Height (m)	2	2

SIZE AND WEIGHT		
Length – Defocused (mm)	120	123
Head Diameter (mm)	26	29
Weight incl. battery (g / oz)	83 / 2.9	106 / 3.7

TECHNOLOGY		
Smart Light Technology		●
Flex Sealing Technology		●
Magnetic Charge System		●
Temperature Control		●
Advanced Focus System	●	●
More Features	Dual Power Source, Rapid Focus	Dimmable, Transportation Lock, Flicker-free, Memory Mode, Backup Mode, Emergency Light, Battery Indicator, Charge Indicator, Low Battery Warning

PACKAGING		
Item no. Box / GTIN	502599 / 4058205028523	502178 / 4058205020428
Content Box	1 Battery Set, Lanyard	1 Battery Set, Lanyard, Magnetic Charging Cable

OPTIONAL ACCESSORIES		
	502700 Lamp Adapter Type F	502248 Lamp Adapter Type B
Further accessories on page 70	0337 Pouch Type D	502259 Charging Station Type A



reddot winner 2021



reddot winner 2021



P6 CORE



P6R CORE



LED		
LED Configuration	1x High Power LED	1x Xtreme LED
Light Functions	Power / Low Power	Boost / Power / Mid Power / Low Power (+ Position, Blink, S.O.S., Strobe)
Luminous Flux ¹ (lm)	300 / 25	900 / 600 / 240 / 15
Beam Distance ¹ (m)	200 / 60	240 / 190 / 120 / 25
Run Time ¹ (h)	3.5 / 25	- / 2 / 6 / 95
Color Temperature (K)	6000 - 7500	6000 - 7500
Color Rendering Index (CRI)	70	65

BATTERY AND CASE		
Battery	3x Micro (AAA) Alkaline 1.5V	1x 18650 Li-ion Battery 3.7V
Battery Capacity ² (Wh / mAh)		9.25 / 2500
IP Level	IP54	IP68
Rechargeable	No	Yes
Charging Time ⁵ (min)		300
Drop Height (m)	2	2

SIZE AND WEIGHT		
Length – Defocused (mm)	117	151
Head Diameter (mm)	32	35
Weight incl. battery (g / oz)	130 / 4.6	170 / 6.0

TECHNOLOGY		
Smart Light Technology		●
Flex Sealing Technology		●
Magnetic Charge System		●
Temperature Control		●
Advanced Focus System	●	●
More Features	Energy Saving, Rapid Focus	Dimmable, Transportation Lock, Flicker-free, Memory Mode, Backup Mode, Emergency Light, Temperature Control System, Battery Indicator, Charge Indicator, Low Battery Warning

PACKAGING		
Item no. Box / GTIN	502600 / 4058205028554	502179 / 4058205020459
Content Box	1 Battery Set, Lanyard	1 Battery Set, Lanyard, Magnetic Charging Cable

OPTIONAL ACCESSORIES		
		502250 Lamp Adapter Type C



P5R CORE

05
02
03

- 01 – Extreme **dust and water prediction (IP68)**
- 02 – **Advanced Focus System** – stepless focusing
- 03 – **Flex Sealing Technology** – can be used for a short time underwater (including the focusing system) to a depth of one meter
- 04 – Personalize the light functions via **Smart Light Technology**
- 05 – Convenient and safe charging the battery thanks to the **Magnetic Charge System**
- 06 – **Constant Light** – constant luminous flux over a long period
- 07 – **Flicker-free** constant light enables optimal and safe illumination

¹⁻⁸ Information on page B4



P7R CORE



THE P-SERIES A TIMELESS CLASSIC



☀️ 1400 lm¹
 ➔ 300 m¹
 ⌚ 90 h¹



- 01** – Extreme **dust and water protection (IP68)**
- 02** – **Advanced Focus System** – stepless focusing
- 03** – **Flex Sealing Technology** – can be used for a short time underwater (including the focusing system) to a depth of one meter
- 04** – **Multi-Core Optics** – homogeneous beam made possible by special faceting of the lens
- 05** – Personalize the light functions via **Smart Light Technology**
- 06** – Integrated **Battery and Charge Status Display**
- 07** – Convenient and safe charging of the battery thanks to the **Magnetic Charge System**



¹⁻⁸ Information on page 84



P-SERIES CORE



LED

	LED Configuration
	Light Functions
	Luminous Flux ¹ (lm)
	Beam Distance ¹ (m)
	Run Time ¹ (h)
	Color Temperature (K)
	Color Rendering Index (CRI)

BATTERY AND CASE

	Battery
	Battery Capacity ² (Wh / mAh)
	IP Level
	Rechargeable
	Charging Time ⁵ (min)
	Drop Height (m)

SIZE AND WEIGHT

	Length – Defocused (mm)
	Head Diameter (mm)
	Weight incl. Battery (g / oz)

TECHNOLOGY

	Smart Light Technology
	Flex Sealing Technology
	Magnetic Charge System
	Multi Core Optics
	Advanced Focus System

More Features

PACKAGING

Item no. Box / GTIN
Content Box

OPTIONAL ACCESSORIES

Further accessories on page 70



P7 CORE

P7R CORE

P17R CORE

1x Power LED	1x Xtreme LED	1x Xtreme LED
Power / Mid Power / Low Power	Boost / Power / Mid Power / Low Power (+ Position, Blink, S.O.S., Strobe)	Boost / Power / Mid Power / Low Power (+ Position, Blink, S.O.S., Strobe)
450 / 250 / 40	1400 / 1000 / 440 / 15	1200 / 900 / 350 / 15
300 / 220 / 100	300 / 210 / 130 / 15	560 / 420 / 270 / 50
1 / 2 / 25	- / 2 / 4 / 90	- / 2.75 / 12 / 200
6000 - 7500	6000 - 7500	6000 - 7500
70	70	65
4x Micro (AAA) Alkaline 1.5V	1x 21700 Li-ion Battery 3.7V	1x LiFePO4 Battery pack 6.4V
	17.76 / 4800	36.48 / 5700
IP54	IP68	IP54
No	Yes	Yes
	270	270
1	2	1
130	158	290
37	35	53
175 / 6.2	202 / 7.1	715 / 25.2
	●	●
	●	
	●	●
	●	
●	●	●
Energy Saving, Rapid Focus	Dimmable, Transportation Lock, Flicker-free, Memory Mode, Backup Mode, Emergency Light, Temperature Control System, Battery Indicator, Charge Indicator, Low Battery Warning	Mode Switch, Dimmable, Transportation Lock, Flicker-free, Memory Mode, Backup Mode, Emergency Light, Safety Ytrion Cell, Rapid Focus, Battery Indicator, Charge Indicator, Low Battery Warning
502180 / 4058205020480	502181 / 4058205020510	502182 / 4058205020541
1 Battery Set, Lanyard	1 Battery Set, Lanyard, Magnetic Charging Cable	1 Set of Batteries, Intelligent Clip, Wall Mount, Power Adapter, Magnetic Charging Cable
	502251 Lamp Adapter Type D	0042 Signal Cone 53 mm

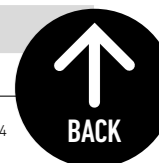

P6R CORE QC



- 01** – Equipped with a **Multicolor LED** with white, red, green and blue light
- 02** – **Multicolor Strobe** – colored flashes of light with irritating glare effect for emergencies
- 03** – **Easy Operation** – the rotary switch enables quick color changes
- 04** – **Advanced Focus System** – stepless focusing



P6R CORE QC

LED	
LED Configuration	1x Power LED
Light Functions (weißes Licht)	Power / Mid Power / Low Power
Luminous Flux ¹ (lm)	270 / 120 / 15
Beam Distance ¹ (m)	335 / 220 / 80
Run Time ¹ (h)	5 / 14 / 110
Color Temperature (K)	6000 - 6500
Color Rendering Index (CRI)	80 (white light)
BATTERY AND CASE	
Battery	1x Li-ion Battery 3.7V
Battery Capacity ² (Wh / mAh)	9.25 / 2500
IP Level	IP54
Rechargeable	Yes
Charging Time ⁵ (min)	300
Drop Height (m)	1.5
SIZE AND WEIGHT	
Length – Defocused (mm)	157
Head Diameter (mm)	42
Weight incl. Battery (g / oz)	207 / 7.3
TECHNOLOGY	
Rapid Focus	●
Advanced Focus System	●
More Features	Multicolor Strobe, Singlecolor Strobe
PACKAGING	
Item no. Box / GTIN	502517 / 4058205026819
Content Box	1 Battery Set, Lanyard, Micro-USB Charging Cable
OPTIONAL ACCESSORIES	
	502251 Lamp Adapter Type D
Further accessories on page 70	502729 Remote Switch Type G

SEEING THE WORLD IN A DIFFERENT LIGHT



LED	RED	GREEN	BLUE
	Maintain night vision ability	Wildlife watching: green light is almost invisible to animals	Forensic analysis: liquids appear with higher contrast
Light Functions	Power / Mid Power / Low Power	Power / Mid Power / Low Power	Power / Mid Power / Low Power
Luminous Flux ¹ (lm)	145 / 60 / 15	220 / 75 / 15	35 / 10 / 5
Beam Distance ¹ (m)	220 / 150 / 70	300 / 190 / 80	50 / 30 / 15
Run Time ¹ (h)	6 / 24 / 70	6 / 20 / 120	7 / 20 / 120



P7R SIGNATURE



THE P-SERIES PREMIUM ILLUMINATION



516



☀️ 2000 lm¹
 ➡️ 330 m¹
 ⌚ 90 h¹

- 01 – Powerful premium flashlight with **Natural Light Technology (80 CRI / 6500K)**
- 02 – **Mode Switch** for direct access to personalized light functions via Smart Light Technology
- 03 – Additional **red secondary light** on the side of the housing, e. g. to maintain the night vision
- 04 – **Hard-anodized housing material** for additional protection against wear and corrosion
- 05 – Extreme **dust and water protection (IP68)**
- 06 – **Flex Sealing Technology** – can be used for a short time underwater (including the focusing system) to a depth of one meter
- 07 – Personalize the light functions thanks to **Smart Light Technology**
- 08 – **Constant Light** – consistent level of brightness over time
- 09 – Integrated **battery and charge status indicator**



PRODUCT VIDEO



MAXIMUM
PERFORMANCE,
STYLISH
DESIGN



P6R SIGNATURE



P7R SIGNATURE



P18R SIGNATURE

P-SERIES SIGNATURE



LED	P6R SIGNATURE	P7R SIGNATURE
LED Configuration	1x Xtreme LED, (1x red LED)	1x Xtreme LED, (1x red LED)
Light Functions	Boost / Power / Mid Power / Low Power (+ Position, Blink, S.O.S., Strobe, Red Light)	Boost / Power / Mid Power / Low Power (+ Position, Blink, S.O.S., Strobe, Red Light)
Luminous Flux ¹ (lm)	1400 / 1100 / 450 / 15	2000 / 1200 / 500 / 15
Beam Distance ¹ (m)	240 / 190 / 110 / 20	330 / 200 / 130 / 20
Run Time ¹ (h)	- / 1.25 / 2.5 / 60	- / 2 / 3.25 / 90
Color Temperature (K)	6000 - 7500	6000 - 7500
Color Rendering Index (CRI)	80	80

BATTERY AND CASE	P6R SIGNATURE	P7R SIGNATURE
Battery	1x 18650 Li-ion Battery 3.6V	1x 21700 Li-ion Battery 3.7V
Battery Capacity ² (Wh / mAh)	10.89 / 3000	17.76 / 4800
IP Level	IP68	IP68
Rechargeable	Yes	Yes
Charging Time ⁵ (min)	225	270
Drop Height (m)	2	2

SIZE AND WEIGHT	P6R SIGNATURE	P7R SIGNATURE
Length – Defocused (mm)	151	158
Head Diameter (mm)	35	35
Weight incl. Battery (g / oz)	170 / 6.0	202 / 7.1

TECHNOLOGY	P6R SIGNATURE	P7R SIGNATURE
Smart Light Technology	●	●
Flex Sealing Technology	●	●
Magnetic Charge System	●	●
Multi-Core Optics	●	●
Advanced Focus System	●	●

More Features	P6R SIGNATURE	P7R SIGNATURE
More Features	Red Alternate Light, Mode Switch, Emergency Light, Temperature Control, Dimmable, Transportation Lock, Flicker-free, Memory Function, Backup Mode, Emergency Light, Battery Indicator, Charge Indicator, Low Battery Warning	Red Alternate Light, Mode Switch, Emergency Light, Temperature Control, Dimmable, Transportation Lock, Flicker-free, Memory Function, Backup Mode, Emergency Light, Battery Indicator, Charge Indicator, Low Battery Warning

PACKAGING	P6R SIGNATURE	P7R SIGNATURE
Item no. Box / GTIN	502189 / 4058205020756	502190 / 4058205020787
Content Box	1 Set of Batteries, Leather Belt Pouch, Lanyard, Magnetic Charging Cable, Pocket Clip, USB Power Adapter, Wall Bracket	1 Set of Batteries, Leather Belt Pouch, Lanyard, Magnetic Charging Cable, Pocket Clip, USB Power Adapter, Wall Bracket

LED	P18R SIGNATURE
LED Configuration	3x Xtreme LED
Light Functions	Boost / Power / Mid Power / Low Power (+ Position, Blink, S.O.S., Strobe)
Luminous Flux ¹ (lm)	4500 / 2600 / 1000 / 30
Beam Distance ¹ (m)	720 / 420 / 260 / 50
Run Time ¹ (h)	- / 2.5 / 4.5 / 70
Color Temperature (K)	6000 - 7200
Color Rendering Index (CRI)	70

BATTERY AND CASE	P18R SIGNATURE
Battery	1x Li-ion Battery Pack 11.1V
Battery Capacity ² (Wh / mAh)	33.3 / 3000
IP Level	IP54
Rechargeable	Yes
Charging Time ⁵ (min)	330
Drop Height (m)	1

SIZE AND WEIGHT	P18R SIGNATURE
Length – Defocused (mm)	171
Head Diameter (mm)	86
Weight incl. Battery (g / oz)	637 / 22.5

TECHNOLOGY	P18R SIGNATURE
Smart Light Technology	●
Flex Sealing Technology	●
Magnetic Charge System	●
Multi-Core Optics	●
Advanced Focus System	●

More Features	P18R SIGNATURE
More Features	X-Lens Technology, Rapid Focus, Dimmable, Transportation Lock, Flicker-free, Memory Function, Backup Mode, Emergency Light, Battery Indicator, Charge Indicator, Low Battery Warning

PACKAGING	P18R SIGNATURE
Item no. Box / GTIN	502191 / 4058205020817
Content Box	1 Set of Batteries, Lanyard, USB Power Adapter, Magnetic Charging Cable



KEY RING LIGHTS



 LEDLENSER



K-SERIES



K4R

LED	
LED Configuration	1x Power LED
Light Functions	Boost / Power / Low Power
Luminous Flux ¹ (lm)	120 / 80 / 20
Beam Distance ¹ (m)	30 / 25 / 10
Run Time ¹ (h)	- / 1 / 3.5

BATTERY AND CASE	
Battery	1x Li-ion Battery 3.7V
Battery Capacity ² (Wh / mAh)	0.67 / 180
Rechargeable	Yes
Charging Time ⁵ (min)	180
IP Level	IP2X

SIZE AND WEIGHT	
Length (mm)	52
Width (mm)	25
Weight incl. Battery (g / oz)	20 / 0.7

FEATURES	
	Transportation Lock, Battery Indicator, Charge Indicator

PACKAGING	
Item no. Box / Gray	Gray: 502574 / 4058205029117
Item no. Box / Rosé-Gold	Rose Gold: 502575 / 4058205029148
Content Box	Carabiner, Key Ring

K6R

LED	
LED Configuration	1x High Power LED
Light Functions	Boost / Power / Low Power (+ red light)
Luminous Flux ¹ (lm)	400 / 200 / 20
Beam Distance ¹ (m)	80 / 50 / 15
Run Time ¹ (h)	- / 1.5 / 10

BATTERY AND CASE	
Battery	1x Li-ion Battery 3.7V
Battery Capacity ² (Wh / mAh)	2 / 550
Rechargeable	Yes
Charging Time ⁵ (min)	180
IP Level	IP2X

SIZE AND WEIGHT	
Length (mm)	62
Width (mm)	30
Weight incl. Battery (g / oz)	30 / 1.1

FEATURES	
	Transportation Lock, Red Light, Battery Indicator, Charge Indicator

PACKAGING	
Item no. Box / Gray	Gray: 502577 / 4058205028318
Item no. Box / Rosé-Gold	Rose Gold: 502578 / 4058205028622
Content Box	Carabiner, Key Ring

K6R Safety

LED	
LED Configuration	1x High Power LED
Light Functions	Boost / Power / Low Power (+ Strobe)
Luminous Flux ¹ (lm)	400 / 200 / 20
Beam Distance ¹ (m)	80 / 50 / 15
Run Time ¹ (h)	- / 1.5 / 8

BATTERY AND CASE	
Battery	1x Li-ion Battery 3.7V
Battery Capacity ² (Wh / mAh)	1.48 / 400
Rechargeable	Yes
Charging Time ⁵ (min)	180
IP Level	IP2X

SIZE AND WEIGHT	
Length (mm)	66
Width (mm)	30
Weight incl. Battery (g / oz)	32 / 1.1

FEATURES	
	Transportation Lock, Shriill Alarm, Battery Indicator, Charge Indicator

PACKAGING	
Item no. Box / Gray	Safety Gray: 502580 / 4058205028370
Item no. Box / Rosé-Gold	Rose Gold: 502581 / 4058205028721
Content Box	Carabiner, Key Ring, Wrist Strap



KIDSLIGHTS



 LEDLENSER



KIDSLIGHTS

LIGHT, FUN AND SAFETY

The Ledlenser KidsLights series lights specifically address the needs and requirements of children. They offer a wide range of uses, from the self-made cave to the safe way to school, a multitude of colorful light functions, quick and easy operation, and practical energy-saving features. And, most importantly, safety always comes first. For instance, glaring effects and the luminous flux are reduced and all headlamps come with safety headbands which open automatically.



Versatile: white light, red light and blue light with optional flashing functions (red and blue)

Clever: Optics with reduced glaring for children's sensitive eyes

Energy-saving: automatic switch-off after 20 minutes (optional)



Practical: integrated metal clip for further attachment options without headband (e. g. on school satchel, backpack, clothing)



Safe: Pressure sensitive headband that releases automatically to prevent accidental injury



KIDLED2*
AAA Alkaline Batteries



KIDLED4R*
Rechargeable



LED		
LED Configuration	1x Power LED (White), 1x LED (Red), 1x LED (Blue)	1x Power LED (White), 1x LED (Red), 1x LED (Blue)
Light Functions	Power (White), Low Power (White), (Power (Red), Blink (Red), Power (Blue), Blink (Blue), Blink (Red / Blue))	Power (White), Low Power (White), (Power (Red), Blink (Red), Power (Blue), Blink (Blue), Blink (Red / Blue))
Luminous Flux ¹ (lm)	40 / 5	40 / 5
Beam Distance ¹ (m)	9 / 2	9 / 2
Run Time ¹ (h)	1.5 / 20	2 / 18
BATTERY AND CASE		
Battery	1 x AAA Alkaline 1.5V	1 x Li-ion 3.7V (intern)
Battery Capacity ² (Wh / mAh)	-	1.036/280
Rechargeable	No	Yes
Charging Time ⁵ (min)	-	60
IP Level	IPX4	IP56
SIZE AND WEIGHT		
Durchmesser (mm)	54	37
Weight incl. Battery (g / oz)	35 / 1.2	25 / 0.9
FEATURES		
	White Light, Red Light, Blue Light, Automatic Switch-Off (optional), Safety Headband, Metal Clip for Mounting as Clip Light	White Light, Red Light, Blue Light, Automatic Switch-Off (optional), Safety Headband, Metal Clip for Mounting as Clip Light, Charge Indicator
PACKAGING (BOX)		
Item no. / GTIN	502537 (Green) / 4058205027038	502535 (Green) / 4058205026970
Item no. / GTIN	502538 (Purple) / 4058205027069	502536 (Purple) / 4058205027007
Content Box	1 Set of Batteries	Micro-USB Charging Cable

* Caution: Not suitable for children under 36 months.
Caution: Use under direct adult supervision.

¹⁻⁸ Information on page 84



KIDSLIGHTS

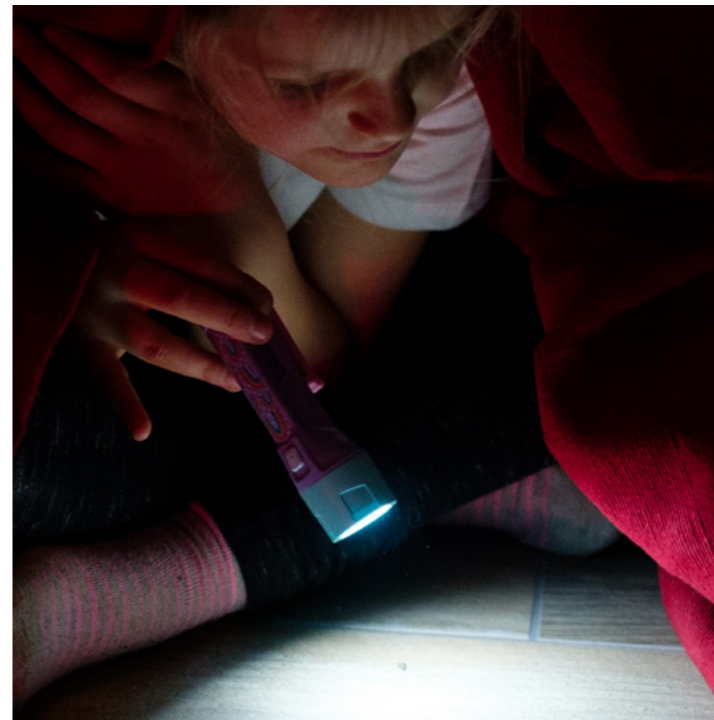

KIDBEAM4

AAA Alkaline Batteries



Exploring with your first own flashlight:
The robust Kidbeam4 lights up in four different colors and impresses with practical, child-specific features such as the integrated clip or the automatic switch-off function.

KIDCAMP6

AAA Alkaline Batteries



For cozy evenings of playing or reading:
The Kidcamp6 provides the right mood and lights up in four different colors. It can be mounted in various ways thanks to the fold-out hook, e. g. in a tent or caravan.

	KIDBEAM4*	KIDCAMP6*
LED		
LED Configuration	1x Power LED (White), 1x LED (Red), 1x LED (Blue), 1x LED (Green)	1x Power LED (White), 1x LED (Red), 1x LED (Blue), 1x LED (Green)
Light Functions	Power (White) / Low Power (White) (+ Power (Red), Power (Blue), Power (Green), Blink (Red und Blue))	Power (White) / Low Power (White) (+ Power (Red), Power (Blue), Power (Green), Blink (Red, Blue und Green))
Luminous Flux ¹ (lm)	70 / 10	60 / 10
Beam Distance ¹ (m)	12 / 5	- / -
Run Time ¹ (h)	4 / 18	8 / 40
BATTERY AND CASE		
Battery	2 x AAA Alkaline 1.5V	3 x AAA Alkaline 1.5V
Battery Capacity ² (Wh / mAh)	-	-
Rechargeable	No	No
Charging Time ⁵ (min)	-	-
IP Level	IP44	IP44
SIZE AND WEIGHT		
Durchmesser (mm)	35	75
Weight incl. Battery (g / oz)	72 / 2.5	95 / 3.4
FEATURES		
	White Light, Red Light, Blue Light, Green Light, Automatic Switch-Off (optional), Clip	White Light, Red Light, Blue Light, Green Light, Automatic Switch-Off (optional), Fold-Out Hook for Hanging Up the Light
PACKAGING (BOX)		
Item no. / GTIN	502754 (Green) / 4058205030861	502753 (Green) / 4058205030847
Item no. / GTIN	502789 (Purple) / 4058205031653	502786 (Purple) / 4058205031561
Content Box	1 set of batteries	1 set of batteries

* Caution: Not suitable for children under 36 months.
Caution: Use under direct adult supervision.

¹⁻⁸ Information on page 84



— X-SERIES:
LIGHT FOR
EXTREME NEEDS

 LEDLENSER

















XP30R 

NEW



Hard Shell Transport Case



LED	
 LED Configuration	30 x High Performance Automotive LEDs
 Light Functions	Boost, 5 Brightness Level (+ Strobe)
 Luminous Flux ¹ (lm)	32,000 / 24,000 / 15,500 / 8500 / 4000 / 500
 Beam Distance ¹ (m)	>2000 / 1900 / 1500 / 1100 / 800 / 300
 Run Time ¹ (h)	- / 0.5 / 0.75 / 1.25 / 2.5 / 16
BATTERY AND CASE	
 Battery	AMPShare Battery powered by BOSCH
 Battery Capacity (Wh / mAh) ²	90 / 5000
 Rechargeable	Yes
 Charging Time ⁵ (min)	80
 IP Level	IP54
SIZE AND WEIGHT	
 B / H / T (mm)	307 x 212 x 180
 Weight incl. Battery (g / oz)	3600 / 127
TECHNOLOGY	
 Extreme Search Beam	●
 Active Cooling Technology	●
 Temperature Control	●
More Features	Charge Indicator, Battery Indicator, Remote Control with up to 200 m range
PACKAGING	
Item no. Transport Case / GTIN	(EU version) 503039 / 4058205035798 (UK version) 502783 / 4058205031264
Contents	Hard Shell Transport Case, Battery System AMPShare - powered by Bosch, Battery Charger, Carrying Strap, Remote Control, Universal Mounting Bracket

¹⁻² Information on page 76

ULTIMATE LIGHT PERFORMANCE MADE IN GERMANY



PRODUCT VIDEO

 32,000 lm¹
 2000 m¹
 16 h¹

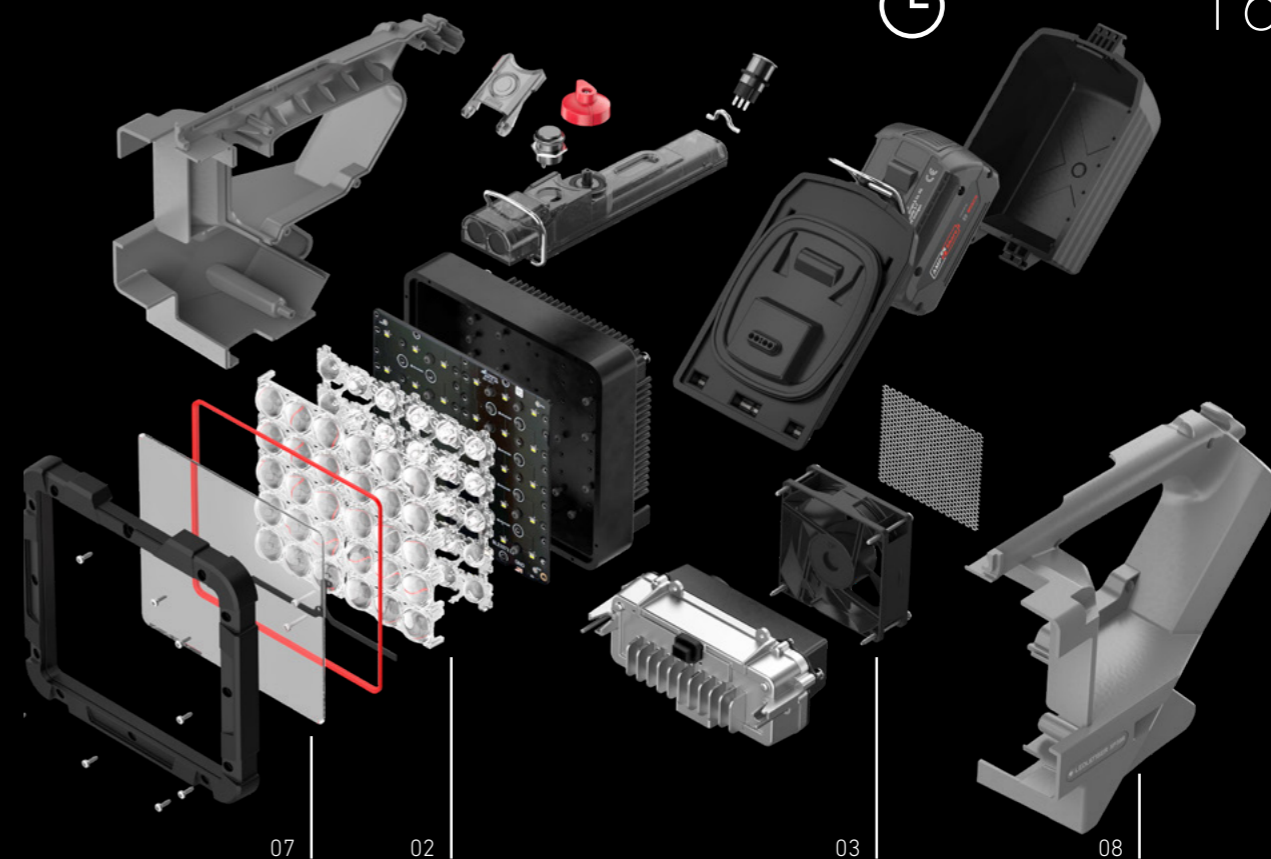

04



- 01** - High-end portable searchlight with up to 32,000 lumens¹
- 02** - Extreme Search Beam - 30 powerful automotive LEDs combined with unique optics for extreme long-range vision without glare at close range
- 03** - Active Cooling Technology - powerful fan for maximum light output over a long period of time
- 04** - AMPShare - powered by Bosch battery with fast charging function
- 05** - Compact dimensions and perfect weight distribution for optimal handling and single-handed operation
- 06** - Remote control with up to 200 m range
- 07** - Extremely robust due to protective elements and robust front glass
- 08** - Screw thread for tripod mounting
- 09** - Made in Germany - development and production in Germany according to highest quality standards



X21R



☀️ 5000 lm¹
 ➡️ 800 m¹
 ⌚ 40 h¹

04 05

01 02 03 06

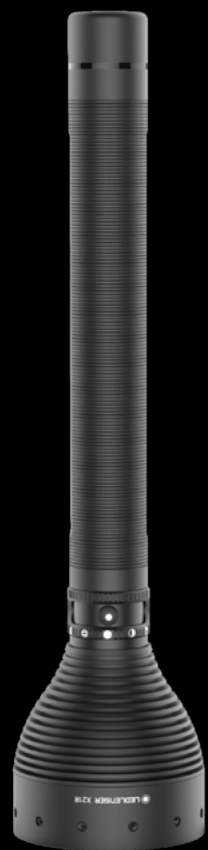

- 01 – Extreme light output** – up to 800 meters¹ beam distance with up to 5000 lumens¹ thanks to seven Xtreme LEDs
- 02 – X-Lens Technology** – precise synchronization of the bundles of rays from several reflector lenses to form an extremely homogeneous, stage-like floodlight or a very sharply focused high beam
- 03 – Advanced Focus System** – stepless focusing
- 04 – High-quality battery system Safety Ytrion Cell** – over 5000 charging cycles without significant loss of capacity
- 05 – Quick to hand** – convenient charging with the **Floating Charge System**
- 06 – Great ease of use** – 7 light functions, 4 light programs, 2 energy modes, and 1 multi-function switch



¹⁻⁸ Information on page 84

EXTREME POWER RECHARGEABLE & MULTIFUNCTIONAL



LED	
🔦 LED Configuration	7x Xtreme LED
🔊 Light Functions	Boost / Power / Low Power (+ Blink, S.O.S., Strobe, Position)
☀️ Luminous Flux ¹ (lm)	5000 / 3500 / 200
➡️ Beam Distance ¹ (m)	800 / 700 / 150
⌚ Run Time ¹ (h)	- / 5 / 40
BATTERY AND CASE	
🔋 Battery	1x LiFePO4 Battery Pack 9.6V
🔋 Battery Capacity ² (Wh / mAh)	48 / 5000
🔌 Rechargeable	Yes
⌚ Charging Time ⁵ (min)	210
☁️ IP Level	IP54
SIZE AND WEIGHT	
📏 Length – defocused (mm)	405
📏 Head diameter (mm)	95
📏 Weight incl. Battery (g / oz)	1315 / 45.9
TECHNOLOGY	
🔦 Smart Light Technology	●
🔦 Rapid Focus	●
🔦 Floating Charge System	●
🔦 Advanced Focus System	●
🔦 X-Lens Technology	●
🔦 Emergency Light	●
🔦 Safety Ytrion Cell	●
🔦 Temperature Control	●
More Features	Energy Saving, Constant Light, Charge Indicator, Battery Indicator, Dimmable, Transportation Lock
PACKAGING	
Item no. Carrying Case / GTIN	501967 / 4058205015394
Contents	1 Battery Set, Floating Charge System, Assembly Material, Power Supply Unit, Roll Protection, Tripod Holder, Carrying Strap, Case
OPTIONAL ACCESSORIES	
	0386 Car Charger

¹⁻⁸ Information on page 76

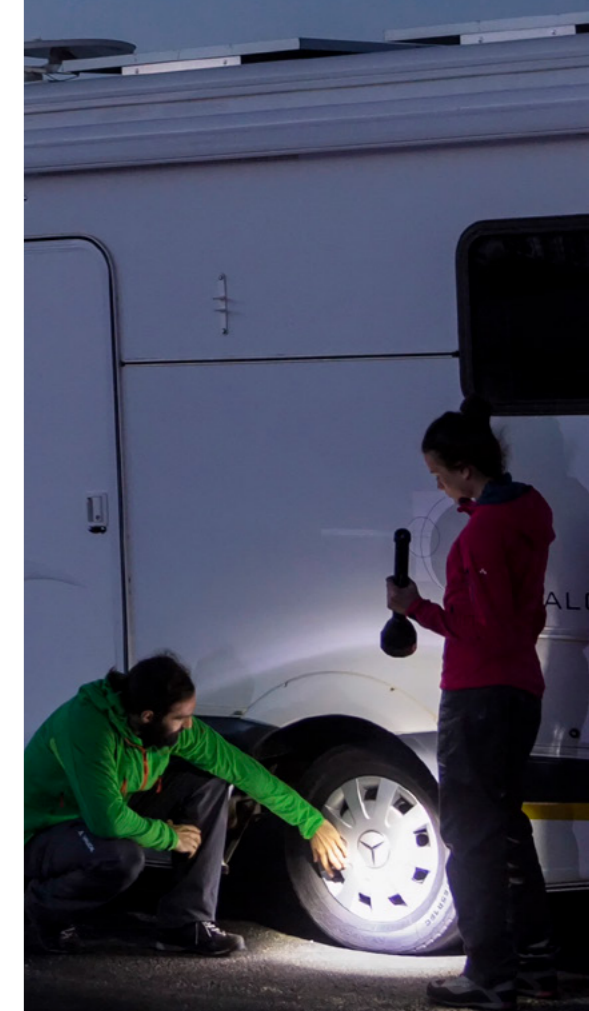

HEADLAMPS



 LEDLENSER

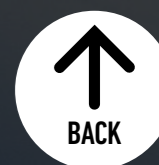

H7R CORE

THE H-SERIES ELEGANT ILLUMINATION



☀️ 1000 lm¹
 ↗️ 250 m¹
 ⌚ 65 h¹

- 01 – Intuitive operation and stepless dimming thanks to the **Wheel switch** on the lamp head
- 02 – Strong **dust and water protection (IP67)**
- 03 – Stepless **swivel mechanism** for vertical alignment of the light cone
- 04 – **Advanced Focus System** – stepless focusing
- 05 – Convenient and safe charging of the battery thanks to the **Magnetic Charge System**
- 06 – Integrated **battery and charge status indicator**
- 07 – **Ledlenser Connecting System** – one interface for many accessories



¹⁻⁸ Information on page 84



H-SERIES CORE



H5 CORE



H5R CORE



LED		
LED Configuration	1x High Power LED	1x High Power LED
Light Functions	Boost / Power / Low Power	Boost / Power / Low Power
Luminous Flux ¹ (lm)	350 / 200 / 15	500 / 300 / 15
Beam Distance ¹ (m)	160 / 120 / 30	200 / 150 / 30
Run Time ¹ (h)	- / 2 / 20	- / 2 / 50
Color Temperature (K)	6000 - 7500	6000 - 7500
Color Rendering Index (CRI)	70	70

BATTERY AND CASE		
Battery	2x Mignon (AA) Alkaline 1.5V	1x Li-ion Battery Pack 3.7V
Battery Capacity ² (Wh / mAh)	-	6.66 / 1800
IP Level	IP67	IP67
Rechargeable	No	Yes
Charging Time ⁵ (min)	-	210
Drop Height (m)	1.5	1.5

SIZE AND WEIGHT		
Head Diameter (mm)	32	32
Weight incl. Battery (g / oz)	178 / 6.3	167 / 5.9

TECHNOLOGY		
Multi-Core Optics		
Flex Sealing Technology	●	●
Magnetic Charge System		●
Fusion Beam		
Advanced Focus System	●	●
More Features	Cooling Technology, Dimmable, Transportation Lock, Energy Saving	Cooling Technology, Temperature Control, Dimmable, Transportation Lock, Flicker-free, Memory Mode, Backup Mode, Battery Indicator, Charge Indicator, Low Battery Warning, Constant Light

PACKAGING		
Item no. Box / GTIN	502193 / 4058205020848	502121 / 4058205020879
Content Box	1 Set of Batteries	1 Set of Batteries, Magnetic Charging Cable

OPTIONAL ACCESSORIES		
Further accessories on page 72	502451 Transp. Silicone Headband	502256 Universal Mounting Bracket



H7R CORE



H15R CORE



H19R CORE



LED			
LED Configuration	1x Xtreme LED	1x Xtreme LED	2x Xtreme LED
Light Functions	Boost / Power / Low Power	Boost / Power / Low Power	Boost / Power / Mid Power / Low Power
Luminous Flux ¹ (lm)	1000 / 600 / 15	2500 / 1000 / 20	3500 / 1600 / 800 / 200
Beam Distance ¹ (m)	250 / 200 / 25	250 / 170 / 20	300 / 230 / 150 / 80
Run Time ¹ (h)	- / 4 / 65	- / 5 / 80	- / 4 / 7 / 20
Color Temperature (K)	6000 - 7500	6000 - 7500	6000 - 7500
Color Rendering Index (CRI)	70	70	70

BATTERY AND CASE			
Battery	1x 21700 Li-ion Battery 3.7V	1x Li-ion Battery Pack 7.4V	1x Li-ion Battery Pack 7.4V
Battery Capacity ² (Wh / mAh)	17.76 / 4800	35.52 / 4800	35.52 / 4800
IP Level	IP67	IP67	IP68
Rechargeable	Yes	Yes	Yes
Charging Time ⁵ (min)	210	330	330
Drop Height (m)	1.5	1.5	1.5

SIZE AND WEIGHT			
Head Diameter (mm)	41	47	68
Weight incl. Battery (g / oz)	259 / 9.1	380 / 13.4	374 / 13.2

TECHNOLOGY			
Multi-Core Optics			●
Flex Sealing Technology	●	●	
Magnetic Charge System	●	●	●
Fusion Beam			●
Advanced Focus System	●	●	
More Features	Cooling Technology, Temperature Control, Dimmable, Transportation Lock, Flicker-free, Memory Mode, Backup Mode, Battery Indicator, Charge Indicator, Low Battery Warning, Constant Light	Cooling Technology, Temperature Control, Dimmable, Transportation Lock, Flicker-free, Memory Mode, Backup Mode, Battery Indicator, Charge Indicator, Low Battery Warning, Constant Light	Temperature Control, Cooling Technology, Optisense Technology, Dimmable, Transportation Lock, Flicker-free, Memory Mode, Backup Mode, Battery Indicator, Charge Indicator, Low Battery Warning, Constant Light, Red Light

PACKAGING			
Item no. Box / GTIN	502122 / 4058205020909	502123 / 4058205020930	502124 / 4058205020961
Content Box	1 Set of Batteries, Magnetic Charging Cable	1 Set of Batteries, Magnetic Charging Cable	1 Set of Batteries, Magnetic Charging Cable

OPTIONAL ACCESSORIES			
Further accessories on page 72	502262 21700 Li-Ion Recharge. Battery	502253 Belt Clip Type A	502256 Universal Mounting Bracket



H19R SIGNATURE



THE FLAGSHIP OF THE SIGNATURE RANGE

☀️ 4000 lm¹
 🔊 330 m¹
 ⌚ 20 h¹

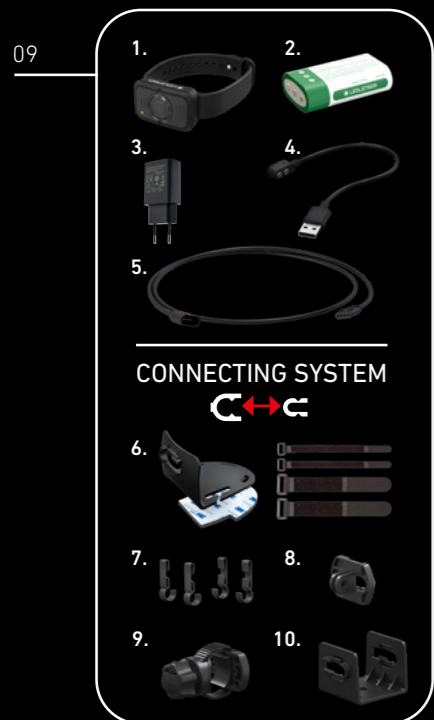
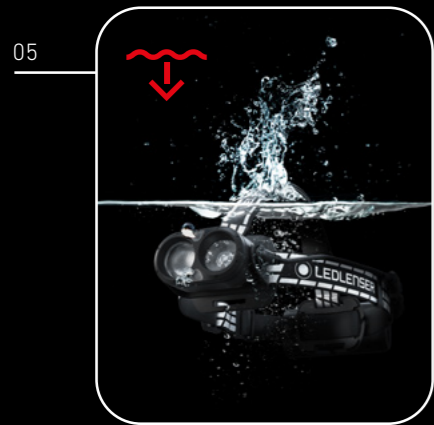

Bluetooth®



- 01 – Fusion Beam** – individually adjustable flood and spotlight for a unique light image with perfect illumination
- 02 – Multi-Core Optics** – homogeneous light image thanks to special faceting of the lens
- 03 – Ledlenser Connect App and Bluetooth® remote control** enable personalization and remote control of the light functions
- 04 – Optisense Technology** – automatic adaptation to the light conditions thanks to the integrated sensor
- 05 – Extreme Dust and Water Protection (IP68)**
- 06 – Additional Red Light** to maintain night vision
- 07 – Stepless Swivel Mechanism** for vertical alignment of the light cone
- 08 – Ledlenser Connecting System** – one interface for many accessory parts
- 09 – Additional Content:** 1. Bluetooth® remote control, 2. Battery, 3. USB power adapter, 4. Magnetic charging cable, 5. Extension cable 6. Helmet connecting kit, 7. Helmet clips, 8. GoPro Adapter, 9. Universal holder, 10. Stand holder ▶ Supplied in a soft case
- 10 – Reflective Headband**



H-SERIES SIGNATURE



THE ULTIMATE LIGHTING FOR THE HIGHEST DEMANDS



H7R SIGNATURE



H19R SIGNATURE

LED		
☀ LED Configuration	1x Xtreme LED	1x Xtreme LED
🔊 Light Functions	Boost / Power / Low Power (+ Strobe, Positon, SOS und Blink)	Boost / Power / Mid Power / Low Power (+ Strobe, Positon, SOS und Blink)
☀ Luminous Flux ¹ (lm)	1200 / 700 / 15	4000 / 1800 / 800 / 200
📏 Beam Distance ¹ (m)	260 / 220 / 25	330 / 250 / 150 / 80
🕒 Run Time ¹ (h)	- / 3.5 / 65	- / 3.5 / 7 / 20
🌡 Color Temperature (K)	6500	6500
📐 Color Rendering Index (CRI)	80	80
BATTERY AND CASE		
🔋 Battery	1x 21700 Li-ion Battery 3.7V	1x Li-ion Battery Pack 7.4V
🔋 Battery Capacity ² (Wh / mAh)	17.76 / 4800	35.52 / 4800
☁ IP Level	IP67	IP68
🔌 Rechargeable	Yes	Yes
🕒 Charging Time ⁵ (min)	210	330
⬇ Drop Height (m)	1.5	1.5
SIZE AND WEIGHT		
📏 Head Diameter (mm)	41	68
⚖ Weight incl. Battery (g / oz)	259 / 9.1	374 / 13.2
TECHNOLOGY		
🔴 Fusion Beam		●
⚙ Flex Sealing Technology	●	
🔌 Magnetic Charge System	●	●
🌡 Temperature Control	●	●
🔌 Advanced Focus System	●	
More Features	Cooling Technology, Emergency Light, Bluetooth®, Dimmable, Transportation Lock, Flicker-free, Memory Mode, Backup Mode, Battery Indicator, Charge Indicator, Low Battery Warning, Constant Light	Mutli-Core Optics, Red Light, Optisense, Cooling Technology, Emergency Light, Bluetooth®, Dimmable, Transportation Lock, Flicker-free, Memory Mode, Backup Mode, Battery Indicator, Charge Indicator, Low Battery Warning, Constant Light
PACKAGING		
Item no. Box / GTIN	502197 / 4058205021081	502198 / 4058205021111
Content Soft Case	1 Set of Batteries, Helmet Clips, Adapter for GoPro, Helmet Holder, Hook-and-Loop straps, Adhesive Pads, Magnetic Charging Cable, Tripod Holder, USB Power Adapter, Universal Holder, Extension Cable	Bluetooth® remote control, 1 Set of Batteries, Helmet Clips, Adapter for GoPro, Helmet Holder, Hook-and-Loop straps, Adhesive Pads, Magnetic Charging Cable, Tripod Holder, USB Power Adapter, Universal Holder, Extension Cable, Adhesive Pads
OPTIONAL ACCESSORIES		
Further accessories on page 72	502451 Transparent Silicone Headband	502256 Universal Mounting Bracket

¹⁻⁴ Information on page 84

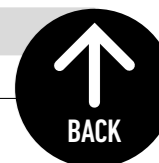

NEO-SERIES

LIGHTER, SMALLER, FASTER

The new Ledlenser NEO series provides you with the perfect light to bring out the best in you during fast-paced activities in the dark. Your NEO headlamp is your partner on the way to your next goal – no matter whether you run on or off the trails, skate, parkour or practice other fast-paced sports where customized lighting is essential. The headlamps of the NEO series are optimized in every detail for their intended use – from the perfect light image and clever light functions to weight, size and sophisticated details. Let the run begin!

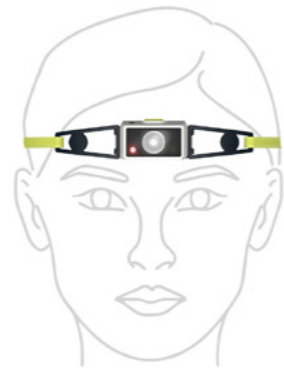

NEO1R 
 ☀ 250 lm¹
 ⌚ 15 h¹
 ⚖ 39 g



ULTRALIGHT AND VERSATILE



Additional red light as a signal light and to maintain night vision capability



Quick and easy battery charging via Magnetic Charge System with status LED



Tilting lamp head for individual adjustment of the light cone



NEO3
 ☀ 400 lm¹
 ⌚ 20 h¹
 ⚖ 97 g



BRIGHT ALLROUNDER FOR SPORTY MISSIONS



Perfect light pattern for fast-moving activities with combined close and long distance light

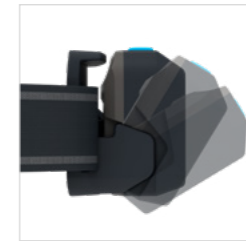

Tilting lamp head for individual adjustment of the light cone



Minimalist, ergonomic design with cable tunnel for perfect fit and wearing; 360° visibility thanks to red flashing rear light; easy operation with three AAA batteries



NEO5R 
 ☀ 600 lm¹
 ⌚ 35 h¹
 ⚖ 104 g



COMPACT POWER FOR AMBITIOUS ATHLETES



Perfect light pattern for fast-moving activities with combined close and long distance light



360° visibility thanks to red flashing rear light and reflective headband; quick and easy battery charging via Magnetic Charge System with status LED



Tilting lamp head for individual adjustment of the light cone



NEO9R 
 ☀ 1200 lm¹
 ⌚ 120 h¹
 ⚖ 199 g



THE PERFECT LIGHT FOR TRAIL RUNNERS



Extremely powerful trail running headlamp with outstanding light image; multiple light sources perfectly illuminate near and far in every situation



Extremely powerful, replaceable battery pack; rechargeable via Magnetic Charge System with status LED



Ergonomic design with removable overhead strap for perfect fit and wearing comfort during outdoor activities; included chest belt as additional attachment option



NEO-SERIES



NEO1R



LED	
LED Configuration	1x High Power LED
Light Functions	Boost / Power / Low Power
Luminous Flux ¹ (lm)	250 / 150 / 20
Beam Distance ¹ (m)	80 / 50 / 15
Run Time ¹ (h)	- / 3 / 15
BATTERY AND CASE	
Battery	1x Li-ion Battery Pack 3.7 V
Battery Capacity ² (Wh / mAh)	2.7 / 730
Rechargeable	Yes
Charging Time ⁵ (min)	180
IP Level	IP67
SIZE AND WEIGHT	
Head Diameter (mm)	48
Weight incl. Battery (g / oz)	39 / 1.4
TECHNOLOGY	
Fusion Beam	
Magnetic Charge System	●
Temperature Control	●
More Features	Low Battery Warning, Battery Indicator, Charge Indicator, Red Light, Transportation Lock, Backup Mode
PACKAGING	
Item no. Box / GTIN	502713 Blue / 4058205029971
Item no. Box / GTIN	502720 White/Green / 4058205030168
Item no. Box / GTIN	502712 Black / 4058205029957
Content Box	Magnetic Charging Cable
OPTIONAL ACCESSORIES	
Further accessories on page 72	0332 Pouch Type H



NEO3



NEO5R



NEO9R



LED		LED		LED	
2x High Power LED	2x High Power LED	2x High Power LED	2x High Power LED	3x Xtreme LED	3x Xtreme LED
Boost / Power / Mid Power / Low Power	Boost / Power / Mid Power / Low Power	Boost / Power / Mid Power / Low Power	Boost / Power / Mid Power / Low Power	Boost / Power / Mid Power / Low Power	Boost / Power / Mid Power / Low Power
400 / 200 / 100 / 20	600 / 300 / 100 / 20	400 / 200 / 100 / 20	600 / 300 / 100 / 20	1200 / 600 / 200 / 20	1200 / 600 / 200 / 20
80 / 60 / 40 / 5	100 / 70 / 40 / 5	80 / 60 / 40 / 5	100 / 70 / 40 / 5	200 / 120 / 60 / 5	200 / 120 / 60 / 5
- / 3 / 6 / 20	- / 4 / 8 / 35	- / 3 / 6 / 20	- / 4 / 8 / 35	- / 5 / 12 / 120	- / 5 / 12 / 120
BATTERY AND CASE		BATTERY AND CASE		BATTERY AND CASE	
3x Micro (AAA) Alkaline 1.5V	1x Li-ion Battery Pack 3.7 V	3x Micro (AAA) Alkaline 1.5V	1x Li-ion Battery Pack 3.7 V	2x 18650 Li-ion Battery Pack. 3.7V	2x 18650 Li-ion Battery Pack. 3.7V
-	6.66 / 1800	-	6.66 / 1800	18.5 / 5000	18.5 / 5000
No	Yes	No	Yes	Yes	Yes
-	240	-	240	330	330
IP54	IP54	IP54	IP54	IP54	IP54
SIZE AND WEIGHT		SIZE AND WEIGHT		SIZE AND WEIGHT	
41	41	41	41	57	57
97 / 3.4	106 / 3.7	97 / 3.4	106 / 3.7	199 / 7.0	199 / 7.0
TECHNOLOGY		TECHNOLOGY		TECHNOLOGY	
●	●	●	●	●	●
●	●	●	●	●	●
●	●	●	●	●	●
Low Battery Warning, Battery Indicator, Rear Light, Transportation Lock, Backup Mode	Low Battery Warning, Battery Indicator, Charge Indicator, Rear Light, Transportation Lock, Backup Mode	Low Battery Warning, Battery Indicator, Rear Light, Transportation Lock, Backup Mode	Low Battery Warning, Battery Indicator, Charge Indicator, Rear Light, Transportation Lock, Backup Mode	Low Battery Warning, Battery Indicator, Charge Indicator, Rear Light, Transportation Lock, Backup Mode	Low Battery Warning, Battery Indicator, Charge Indicator, Rear Light, Transportation Lock, Backup Mode
PACKAGING		PACKAGING		PACKAGING	
502718 Blue / 4058205030106	502716 Blue / 4058205030052	502718 Blue / 4058205030106	502716 Blue / 4058205030052	502715 Blue / 4058205030021	502715 Blue / 4058205030021
502719 White / 4058205030137	502757 White / 4058205030885	502719 White / 4058205030137	502757 White / 4058205030885	502324 Black / 4058205024167	502324 Black / 4058205024167
502717 Black / 4058205030083	502323 Black / 4058205024136	502717 Black / 4058205030083	502323 Black / 4058205024136		
1 Set of Batteries, Comfort Pad	1 Battery Pack, Magnetic Charging Cable, Comfort Pad, Chest Strap	1 Set of Batteries, Comfort Pad	1 Battery Pack, Magnetic Charging Cable, Comfort Pad, Chest Strap	1 Battery Pack, Magnetic Charging Cable, Comfort Pad, Overhead Strap, Chest Strap	1 Battery Pack, Magnetic Charging Cable, Comfort Pad, Overhead Strap, Chest Strap
OPTIONAL ACCESSORIES		OPTIONAL ACCESSORIES		OPTIONAL ACCESSORIES	
0332 Pouch Type H	0332 Pouch Type H	0332 Pouch Type H	0332 Pouch Type H	502823 2x18650 Li-ion Rech. Bat. Pack	502823 2x18650 Li-ion Rech. Bat. Pack



— CLIPLIGHT CU2R



TO
SEE
AND
BE
SEEN!

TIP💡

The CU2R can be easily used as a **BACKLIGHT FOR MANY headlamps** for example e. g. HF-Series (p. 9) or NEO1R (p. 54)

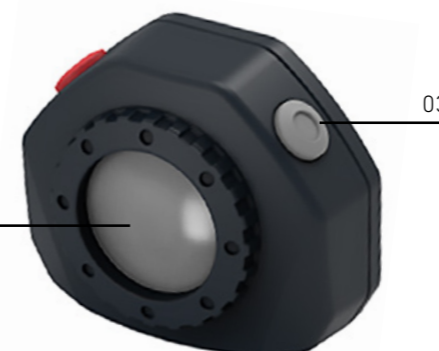

LED	
🔦 LED Configuration	1x Power LED (White), 2x LED (Red)
🔊 Light Functions	Power (White), Low Power (White), (+ Power (Red), Blink (White), Blink (Red))
☀️ Luminous Flux ¹ (lm)	40 / 5
📏 Beam Distance ¹ (m)	9 / 2
🕒 Run Time ¹ (h)	2 / 18
BATTERY AND CASE	
🔋 Battery	1 x Li-ion 3.7V (internal)
🔋 Battery Capacity ² (Wh / mAh)	1036 / 280
🔌 Rechargeable	Yes
🕒 Charging Time ³ (min)	60
☁️ IP Level	IPX4
SIZE AND WEIGHT	
📏 Durchmesser (mm)	37
📏 Weight incl. Battery (g / oz)	25 / 0.9
FEATURES	
	Additional White and Red Flashing Light, Metal Clip for Attachment as Clip Light, Transportation Lock, Wrist Strap
PACKAGING (BOX)	
Item no. / GTIN	502730 / 4058205030366
Content Box	Micro-USB Charging Cable, Wrist Strap

CU2R is your trusted light partner that provides extra everyday safety in dim conditions and beyond – whether it's on a walk with the dog, on an evening run during rush hour or in everyday life as a rear light on clothing or backpack.

01 – Compact, lightweight and versatile signal light with reflective wristband to increase safety in the dark

02 – One white LED and two extra bright red LEDs offering two modes (power, blink)

03 – Intuitive operation with two separate switches for white light and red light

04 – Elastic strap with hook-and-loop closure and metal clip for quick and flexible attachment, e. g. on upper arm, clothing or backpack



¹⁻⁸ Information on page 84

OUTDOOR LANTERNS



 LEDLENSER



ML6 CONNECT WL



 750 lm¹ —
 180 h¹ —

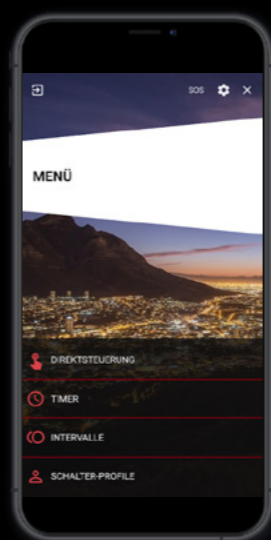

GLARE-FREE 360° ILLUMINATION WITH REMOTE CONTROL



- 01 – Micro Prism Technology – patented⁴ lens technology** for glare-free light and high energy efficiency
- 02 – Ledlenser Connect App** and wireless **Bluetooth® remote control** enable personalization and remote control of the light functions
- 03 – Infinitely dimmable** via three-way switch
- 04 – Powerbank function** with USB connection for charging electronic devices
- 05 – Red light** to maintain night vision ability
- 06 – Rubber hook** for hanging the light, integrated magnet for mounting it on metal surfaces, and a removable stand with a built-in metal hook that can be flipped out to provide more light mounting options
- 07 – Convenient and safe charging** via **Magnetic Charge System**
- 08 – Integrated battery and charge status indicator**



ML-SERIES



ML4

ML4 Warm Light

LED		
LED Configuration	9x Power LED, 9x LED Rot	9x Power LED, 9x LED Rot
Light Functions	Boost / Power / Mid Power / Low Power (+ Blink, alle Light Functions auch in Rot)	Boost / Power / Mid Power / Low Power (+ Blink, alle Light Functions auch in Rot)
Luminous Flux ¹ (lm)	300 / 150 / 50 / 5	300 / 150 / 50 / 5
Beam Distance ¹ (m)	-	-
Run Time ¹ (h)	- / 2.5 / 8 / 45	- / 2.2 / 7 / 40
BATTERY AND CASE		
Battery	1x 14500 Li-ion Battery 3.7V	1x 14500 Li-ion Battery 3.7V
Battery Capacity ² (Wh / mAh)	2.77 / 750	2.77 / 750
Rechargeable	Yes	Yes
Charging Time ⁵ (min)	150	150
IP Level	IP66	IP66
SIZE AND WEIGHT		
Diameter (mm)	34.5	34.5
Height (mm)	97	97
Weight incl. Battery (g / oz)	71 / 2.5	71 / 2.5
TECHNOLOGY		
Micro Prism Technology	●	●
Temperature Control	●	●
Powerbank Function		
Magnetic Charge System	●	●
Dual Power Source	●	●
More Features	Low Battery Warning, Charge Indicator, Battery Indicator, Transportation Lock, Red Light	Low Battery Warning, Charge Indicator, Battery Indicator, Transportation Lock, Red Light
PACKAGING		
Item no. Window Box / GTIN	502053 / 4058205017886	502231 / 4058205022125
Content Box	1 Set of Batteries, Magnetic Charging Cable	1 Set of Batteries, Magnetic Charging Cable
OPTIONAL ACCESSORIES		
Further accessories on page 72	502271 USB Adapter 2.4A	502271 USB Adapter 2.4A



ML6

ML6 Warm Light

ML6 Connect WL

LED			
LED Configuration	18x Power LED, 6x LED Rot	18x Power LED, 6x LED Rot	18x Power LED, 6x LED Rot
Light Functions	Boost / Power / Low Power (+ Blink, Pulse, S.O.S., Strobe, all functions also in red)	Boost / Power / Low Power (+ Blink, Pulse, S.O.S., Strobe, all functions also in red)	Boost / Power / Mid Power / Low Power (+ Blink, Pulse, Position, Strobe, S.O.S., Alpine emergency signal, all functions also in red)
Luminous Flux ¹ (lm)	750 / 550 / 5	750 / 550 / 5	750 / 550 / 100 / 5
Beam Distance ¹ (m)	-	-	-
Run Time ¹ (h)	- / 4 / 240	- / 3.5 / 200	- / 3.5 / 12 / 180
BATTERY AND CASE			
Battery	1x 18650 Li-ion Battery 3.6V	1x 18650 Li-ion Battery 3.6V	1x 18650 Li-ion Battery 3.6V
Battery Capacity ² (Wh / mAh)	10.89 / 3000	10.89 / 3000	10.89 / 3000
Rechargeable	Yes	Yes	Yes
Charging Time ⁵ (min)	300	300	300
IP Level	IP66	IP66	IP66
SIZE AND WEIGHT			
Diameter (mm)	42	42	45
Height (mm)	178	178	178
Weight incl. Battery (g / oz)	280 / 9.9	280 / 9.9	260 / 9.2
TECHNOLOGY			
Micro Prism Technology	●	●	●
Temperature Control	●	●	●
Powerbank Function	●	●	●
Magnetic Charge System			●
Dual Power Source			
More Features	Low Battery Warning, Charge Indicator, Battery Indicator, Dimmable, Transportation Lock, Red Light, Memory Mode	Low Battery Warning, Charge Indicator, Battery Indicator, Dimmable, Transportation Lock, Red Light, Memory Mode	Low Battery Warning, Charge Indicator, Battery Indicator, Dimmable, Transportation Lock, Red Light, Bluetooth®, Memory Mode, Emergency Light
PACKAGING			
Item no. Window Box / GTIN	500929 / 4058205011259	502084 / 4058205017916	502201 / 4058205021203
Content Box	1 Set of Batterie, Stand, Transport Bag, Micro-USB Cable	1 Set of Batterie, Stand, Transport Bag, Micro-USB Cable	1 Set of Batterie, Stand, Transport Bag, Magnetic Charging Cable
OPTIONAL ACCESSORIES			
Further accessories on page 72	502126 Flex3 Powerbank	502126 Flex3 Powerbank	502126 Flex3 Powerbank



— PORTABLE ENERGY FLEX-SERIES



 LEDLENSER



FLEX-SERIES: THE FUTURE OF PORTABLE ENERGY



FOR 21700 BATTERIES

FLEX5

FLEX10

TECHNICAL SPECS	Powerbank+	Powerbank+
↗ Length (mm)	103	120
↔ Width (mm)	41	54
↑↓ Height (mm)	28	29
⚖ Weight with Battery (g / oz)	126 / 4.4	235 / 8.3
⚖ Weight without Battery (g / oz)	55 / 1.9	164 / 5.8
TECHNOLOGY		
🔋 Battery	1x 21700 Li-ion Battery 3.7V	2x 21700 Li-ion Battery 3.7V
🔋 Battery Capacity ² (Wh / mAh)	16.65 / 4500	33.30 / 9000
☁ IP Level	IP65	IP65
🔌 Rechargeable	Yes	Yes
🕒 Charging Time ⁵ (min)	140	240
📊 Energy Status	Battery Indicator, Charge Indicator, Low Battery Warning	Battery Indicator, Charge Indicator, Low Battery Warning
FEATURES	6-IN-1	6-IN-1
	<ol style="list-style-type: none"> 1. Powerbank with replaceable battery 2. IP65 – water and dust protection 3. Battery Charger (up to 30 % shorter charging time – compared to charging in a P7R CORE / WORK / SIGNATURE) 4. Safe Battery Storage 5. Double protection against short circuit (box and battery) 6. Battery Charge Indicator 	<ol style="list-style-type: none"> 1. Powerbank with replaceable battery 2. IP65 – water and dust protection 3. Battery Charger (up to 30 % shorter charging time – compared to charging in a P7R CORE / WORK / SIGNATURE) 4. Safe Battery Storage 5. Double protection against short circuit (box and battery) 6. Battery Charge Indicator for both batteries
MATCHES		
	H7R Core, H7R Signature, P7R Core, P7R Signature	H7R Core, H7R Signature, P7R Core, P7R Signature
PACKAGING		
Item no. Box / GTIN	502511 / 4058205026697	502127 / 4058205019286
Content	1 Rechargeable Battery, USB Cable (USB-A to USB-C)	2 Rechargeable Batteries, USB Cable (USB-A to USB-C)

FLEX10 ^{rechargeable}

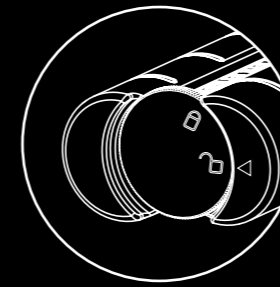

Locking wheel for maximum reliability

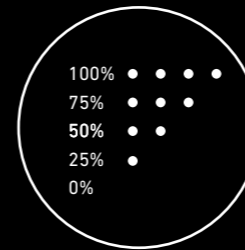

Separate charge level indicators

UP TO 30% FASTER CHARGING
(Compared to charging in a Ledlenser P7R CORE / WORK / SIGNATURE)

Water and dust protection IP65/
special USB ports



Powerbank – new portable power! Innovative 6-in-1-System

Flexible, sustainable, powerful – that distinguishes our new Flex series; the ideal addition for all outdoor activities. The rechargeable batteries of the new Ledlenser powerbanks can be removed at any time and are easy to swap out after being drained.

Therefore, the powerbanks can charge the 18650 respectively 21700 batteries used in compatible Ledlenser lights and in other electronic devices.

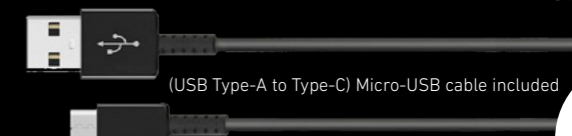

USB
TYPE-C



FLEX-SERIES: EVEN MORE POWER ON THE GO



► FOR 18650 BATTERIES

FLEX3

FLEX7

TECHNICAL SPECS	Powerbank+	Powerbank+
↗ Length (mm)	109	109
↔ Width (mm)	27	47
↑ Height (mm)	27	27
⚖ Weight with Battery (g / oz)	88 / 3.1	164 / 5.8
⚖ Weight without Battery (g / oz)	40 / 1.4	116 / 4.1
TECHNOLOGY		
🔋 Battery	1x 18650 Li-ion Battery 3.6V	2x 18650 Li-ion Batteries 3.6V
🔋 Battery Capacity ² (Wh / mAh)	12.34 / 3400	24.68 / 6800
☁ IP Level	IP65	IP65
🔄 Rechargeable	Yes	Yes
🕒 Charging Time ⁵ (min)	240	240
Energy Status	Battery Indicator, Charge Indicator, Low Battery Warning	Battery Indicator, Charge Indicator, Low Battery Warning
FEATURES	6-IN-1	6-IN-1
	<ol style="list-style-type: none"> 1. Powerbank with replaceable battery 2. IP65 – water and dust protection 3. Battery Charger (up to 30 % shorter charging time – compared to charging in a P6R CORE / WORK / SIGNATURE) 4. Safe Battery Storage 5. Double protection against short circuit (box and battery) 6. Battery Charge Indicator 	<ol style="list-style-type: none"> 1. Powerbank with replaceable battery 2. IP65 – water and dust protection 3. Battery Charger (up to 30 % shorter charging time – compared to charging in a P6R CORE / WORK / SIGNATURE) 4. Safe Battery Storage 5. Double protection against short circuit (box and battery) 6. Battery Charge Indicator for both batteries
MATCHES		
	P6R Core, P6R Signature	P6R Core, P6R Signature
PACKAGING		
Item no. Box / GTIN	502126 / 4058205019255	502125 / 4058205019224
Contents Box	1 Rechargeable Battery, Micro-USB Cable	2 Rechargeable Batteries, Micro-USB Cable

¹⁻⁸ Information on page 76



ACCESSORIES FLASHLIGHTS

C = Core
S = Signature

Item no.	MODEL	P2R C	P3 C	P4 C	P4R C	P5 C	P5R C	P6 C
0337	Pouch Type D	•	•			•		
502249	Lamp Adapter Type B						•	
0362	Universal Mounting System							•
501025	Remote Switch Type E							•
0380	USB Car Charger	•			•		•	
502271	USB Adapter 2.4A	•			•		•	
502265	Magnetic Charging Cable Type A						•	
502259	Charging Station Type A						•	
502596	Li-Ion direct USB Rech. Battery 3.6 V / 880 mAh						•	
500985	14500 Li-Ion rechargeable battery 750 mAh					•	•	

Item no.	MODEL	P6R C	P7 C	P7R C	P6R C QC	P6R S	P7R S
0333	Pouch Type A		•				
0342	Pouch Type G			•	•	•	•
502269	Leather Pouch Type D			•			•
0323	Tactical Professional Holster Type B		•	•			•
502250	Lamp Adapter Type C	•					
502251	Lamp Adapter Type D			•	•		•
0317	Intelligent Clip Type C		•				
0362	Universal Mounting System	•	•	•	•		•
501033	Magnetic Mount	•	•	•	•	•	•
502237	Signal Cone 35.1mm Orange	•		•		•	•
0040	Signal Cone 37mm Orange		•				
502238	Color Filter Set 35.1mm	•		•		•	•
502729	Remote Switch Type G				•		
0380	USB Car Charger	•		•	•	•	•
502271	USB Adapter 2.4A	•		•	•	•	•
502265	Magnetic Charging Cable Type A	•		•		•	•
502260	Charging Station Type B	•		•		•	•
502262	21700 Li-ion Rechargeable Battery 4800mAh			•			•
502595	Li-Ion direct USB Rechargeable Battery 3.6 V / 2500 mAh	•			•	•	
502126	Powerbank Flex3	•			•	•	
502125	Powerbank Flex7	•			•	•	
502511	Powerbank Flex5			•			•
502127	Powerbank Flex10			•			•
501001	Li-Ion Rechargeable Battery 3.6 V / 3000 mAh	•			•	•	



Item no. 502256
Universal Mounting Bracket
Stable universal fastening to cylindrical objects

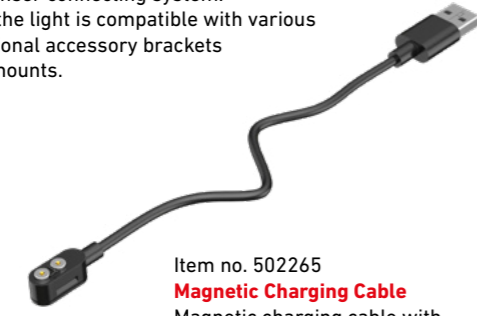

Item no. 502265
Magnetic Charging Cable
Magnetic charging cable with Standard USB A plug



Item no. 502249
Lamp Adapter Type B
The adapter enables the connection between flashlights and the versatile Ledlenser connecting system. Now the light is compatible with various additional accessory brackets and mounts.



Item no. 0342
Pouch
Belt bag made of robust polyamide fabric with elastic side walls



Item no. 502271
USB Adapter 2.4A
Compact 2.4A USB power adapter

Item no.	MODEL	P17R C	P18R S
0042	Signal Cone 53 mm Orange	•	
0380	USB Car Charger		•
502271	USB Adapter 2.4A		•
502265	Magnetic Charging Cable Type A		•



Diverse Item no.
Signal Cone
The plastic plug-in attachment quickly transforms a flashlight into a versatile red signal light at any time, e. g. for signal light





Item no. 0317
Intelligent Clip
Practical belt clip for attachment to the pants, can be rotated 360 rotated



Item no. 502308
Color Filter Set
Four high quality color filters: Red maintains night vision ability. Green and red are suitable for animal observation, among other things. Yellow improves visibility in fog. Blue improves the visibility of liquids



Item no. 502262
Charging Station
Professional charging station incl. magnetic charging cable, compatible with 5 Station Charging Panel



Item no. 502269
Leather Pouch
durable leather protective bag



Item no. 0362
Universal Mounting System
This universal mounting fixes flashlights with a diameter of 25-34 mm securely to tripods, rods and tubes in next to no time. The light and fixation are aligned in parallel



ACCESSORIES HEADLAMPS

C = Core
S = Signature

Item no.	MODEL	HF4R C	HF6R C	HF8R C	H5 C	H5R C	H7R C	H15R C	H19R C
0332	Pouch Type H	•	•	•	•	•			
502253	Belt Clip Type A							•	•
502314	Helmet Connecting Kit Type H	•	•	•	•	•	•	•	•
502313	Helmet Band Fixing Clip Type A				•	•	•	•	•
502256	Universal Mounting Bracket Type E	•	•	•	•	•	•	•	•
502451	Transparent Silicone Headband Type A				•	•	•	•	•
502469	Headband+Overheadband Core				•	•	•	•	•
502311	Bluetooth® Remote Control Type A			•					
502271	USB Adapter 2.4A						•	•	•
502265	Magnetic Charging Cable Type A	•	•	•			•	•	•
502312	Extension Cable Type C						•	•	
502262	21700 Li-ion Recharge. Battery 4800mAh						•		
502411	Bluetooth® 2x 21700 Batterybox						•	•	
502511	Powerbank Flex5						•		
502127	Powerbank Flex10						•		
502310	2x 21700 Li-Ion Recharge. Battery Pack						•	•	
502929	USB-C Adapter 20W	•	•	•					

H7R S	H19R S
•	•
•	•
•	•
•	•
•	•
•	•
•	•
•	•
•	•
•	•
•	•
•	•
•	•



Item no. 502253
Belt Clip Type A
Belt clip for lights and batteries

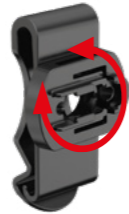

Item no. 502314
Helmet Connecting Kit Type H
Stable helmet holder system for a wide variety of helmet models



Item no. 502256
Universal Mounting Bracket
Stable universal fastening for rods



Item no. 502312
Extension Cable
Practical extension cable (120 cm) that is plugged in between the lamp head and the battery box - so the battery can easily be stowed in the backpack



Item no. 502265
Magnetic Charging Cable
Magnetic charging cable with standard USB-A connector

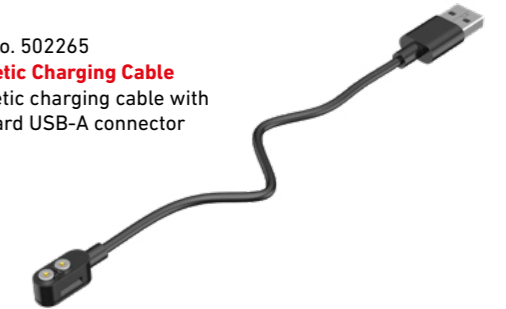

ACCESSORIES LANTERNS

Item no.	MODEL	NE01R	NE03	NE05R	NE09R
0332	Pouch Type H	•	•	•	•
502823	2x 18650 Li-ion Rechargeable Battery				•
502265	Magnetic Charging Cable Type A	•		•	•
502929	USB-C Adapter 20W	•		•	•



Item no.	MODEL	ML4/WL	ML6/WL	ML6 CWL
502311	Bluetooth® Remote Control Type A			•
502271	USB Adapter 2.4A	•	•	•
502265	Magnetic Charging Cable Type A			•
502595	Li-Ion direct USB rech. Battery 3.6 V / 2500 mAh		•	•
502596	Li-Ion direct USB rech. Battery 3.6 V / 880 mAh	•		
500985	14500 Li-Ion rechargeable Battery 750 mAh	•		
502126	Powerbank Flex3		•	•
502125	Powerbank Flex7		•	•
500986	14500 Li-Ion Battery 750 mAh & external charger	•		
501001	Li-Ion rechargeable Battery 3.6 V / 3000 mAh	•	•	



— TECHNOLOGIES,
ABOUT US, WARRANTY
AND MORE



Ledlenser-Hauptsitz in Solingen

 LEDLENSER



LEDLENSER TECHNOLOGY ABC

From innovative lenses and advanced light functions to future-oriented power supplies - we work tirelessly to improve our technology to further expand our lead. Here are some examples:

ADAPTIVE LIGHT BEAM NEW

Our Adaptive Light Beam technology dims and focuses automatically. This way, the light is adapted to changing environments and obstacles; from uneven forest ground and wet sidewalks to narrow machine compartments – without manual control. The system detects blinding reflections as well as overall light conditions and controls all light sources separately. This does not only result in an ideal illumination and focusing, but it also enables completely hands-free use, with an extended battery runtime.



ACTIVE COOLING TECHNOLOGY NEW

High luminosity requires special measures. A powerful fan actively cools down the high-end LED and allows maximum light output over long periods of time – while remaining consistently energy-efficient.

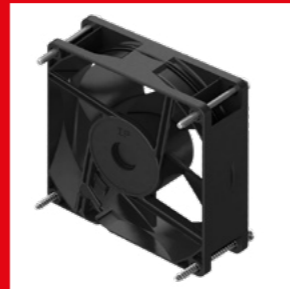

DIGITAL ADVANCED FOCUS SYSTEM NEW

Our patent-pending Digital Advanced Focus System (dAFS) allows a virtually seamless transition from homogeneous flood-light to focused spotlight. Its efficiency delights even experts. The technology enables a slim design, ideal lighting for different ranges and permanent peripheral vision.

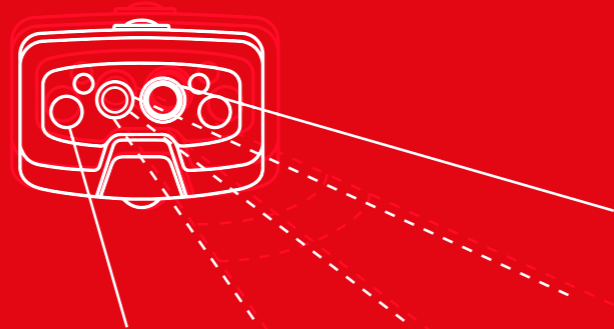

EXTREME SEARCH BEAM NEW

Our Extreme Search Beam consists of several powerful LEDs and a unique optical system for extreme long-range vision. The light is sharply focused to prevent glare at close range. The ultimate light beam for long-range vision.



ADVANCED FOCUS SYSTEM (AFS)

Galileo swore by the power of lenses; Newton by the power of reflectors. We have simply combined the two Technologies – only better than anyone before. The result: our patented Advanced Focus System (AFS), which allows a seamless transition from homogeneous low beam to sharply focused high beam.

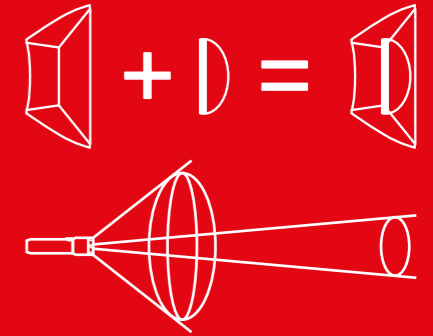

COOLING TECHNOLOGY

Cooling Technology (CT) ensures your head stays cool even when your light is at maximum power. Our CT products reduce LED heat to the optimal level by means of the intelligent use of cooling elements. This technology is also used to cool computer chips and ensures highly efficient use of energy, increased illuminating power, and especially long-lasting LEDs.

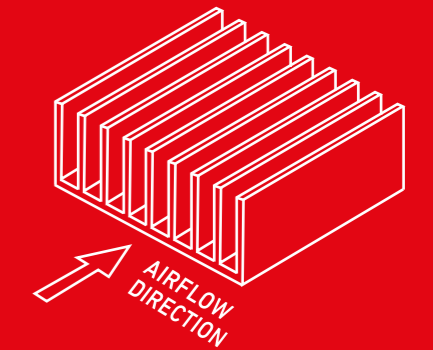

DUAL POWER SOURCE

Our Dual Power Source allows you to use the full performance of your Ledlenser at any time – no matter what power source you have available. This technology recognizes the power source and you can therefore choose between the rechargeable Ledlenser battery or a disposable battery. Extremely practical for long trips without a power point.

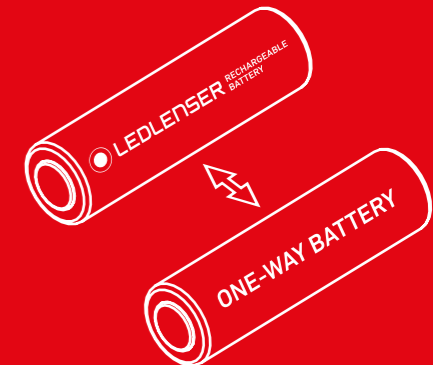

EMERGENCY LIGHT

This feature turns your flashlight into an emergency light: If the power goes out while your Ledlenser is on the charging base, it will automatically turn on. So the light helps you find your way around, e. g. to the breaker panel.



FLOATING CHARGE SYSTEM

Grab-and-go wireless charging. The Floating Charge System is a wall-mounted magnetic charging system, getting the light ready to go with a simple flick of the wrist. It also offers USB charging with an adapter system that can be plugged into standard outlets or car lighters.





FLEX SEALING TECHNOLOGY

The innovative Flex Sealing Technology ensures that the electronic parts of the lamp head are completely sealed off, to protect against the penetration of water and dust. This flexible system maintains the seal, even when the Advanced Focus System is used. The focus can even be used underwater.



FUSION BEAM

By combining different LEDs and lenses, lights with Fusion Beam have a unique, application-optimized illumination. This simultaneously enables a homogenous close-up wide flood beam and sharply focused long-distance beam. The intensity of the flood and spot beams can be individually adjusted thanks to independent controls for each light source.



MAGNETIC CHARGE SYSTEM

With the Magnetic Charge System, the charging cable can quickly and easily be attached to the light. The connection for charging the battery is made via magnetic contacts. When the contacts approach each other, the charging cable automatically pairs with the light. The connection is automatically released under load.

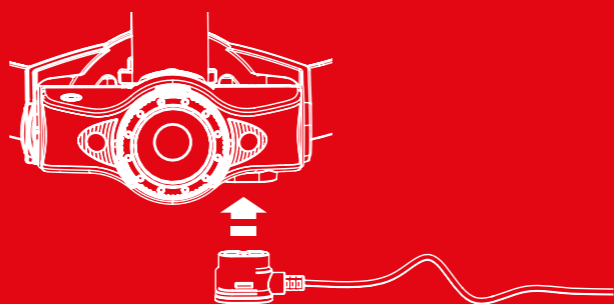

MULTI-CORE OPTICS

Multi-Core Optics harness and direct the light emitted from extremely powerful, next-generation LEDs. The special faceted lens tames and directs the light, resulting in a homogeneous beam and aesthetic illumination.



NATURAL LIGHT

In certain situations the perceived color of light differs. Ledlenser therefore not only supplies extremely bright, but also extremely natural (CRI) over 90. This ensures true color rendering, even in the deep red color range.

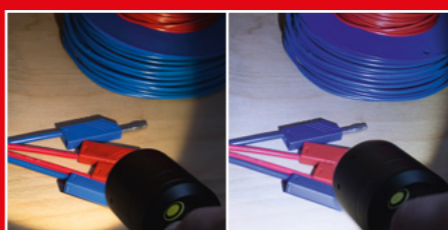

CRI 90, 4000 K

CRI 65, 6500 K



RAPID FOCUS

When focusing or defocusing the flashlight or headlamp, the reflector lens moves in relation to the LED. To ensure this process is as quick and ergonomic as possible we developed Rapid Focus: a single-hand mechanism that allows the light beam to be adjusted as fast as lightning.

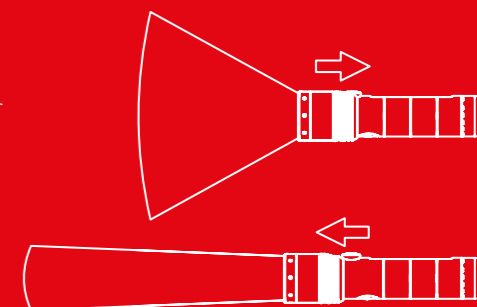

SAFETY YTRION CELL

Ledlenser's Safety Ytrion Cell is a special lithium iron phosphate battery with unique properties: The technology combines high energy density with superior durability and safety, even in rough use and adverse storage conditions.



SMART LIGHT TECHNOLOGY (SLT)

This innovation turns a Ledlenser into your personal lighting tool: A micro-controller allows individual ranges of functions to be programmed to different touch and switch combinations. That way, you always have the perfect light mode at hand.

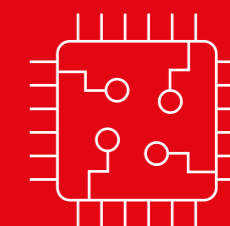

Video Smart Light Technology



TEMPERATURE CONTROL

Our lights stay cool, even when they work hard. Thanks to the intelligent and fully automated temperature control, a Ledlenser never gets too hot, no matter how much it is used. This protects you from burns and the LED from overheating.



X-LENS TECHNOLOGY

This technology is an enhancement of the Advanced Focus System. It can merge virtually any number of reflector lenses and synchronizes their individual light beams into a perfect beam, resulting in a high-grade, homogeneous floodlight in unfocused mode and our most sharply focused high beam to date.



IT TAKES EIGHT MINUTES FOR THE LIGHT OF THE SUN TO REACH THE EARTH – OURS ONLY TAKES THE PUSH OF A BUTTON

The sun and Ledlenser have something in common: We create light for the whole world! We are devoted to this task with all our energy and capability. The quality products made by Ledlenser prolong daylight and therefore, enable being active when dusk sets in or even during total darkness. They bring light into the darkest corners and in doing so, enable precise and professional work at any time.

WHAT DISTINGUISHES US

- › One of the global market leaders in portable lights. That includes: Flashlights, headlamps, work lights, floodlights, lanterns, EX-protected lights
- › „German Engineering & Design“: In-house development, production and quality assurance
- › Inventor of the trendsetting and patented³ Advanced Focus System
- › 7-year warranty⁴ for most products in connection with online registration
- › More than 100 industrial property rights as well as more than 200 awards and prizes for our products
- › More than 650 employees worldwide
- › Company-owned offices in Germany, China, USA, Yespan, Denmark, United Kingdom, Italy and Switzerland
- › Worldwide collaboration with more than 30 master distributors

OUR PRODUCTION PLANT IN CHINA

To ensure that our bright ideas see the light of day, we clearly divided up our tasks: “Engineered in Germany, produced in China”. Our production expertise is concentrated at our location in Yangjiang, Guangdong. Every product is manufactured and tested here; from prototype to mass production.

The checklist for quality control includes 24 tests: Endurance, extreme temperatures, water, salt, impact, pressure and more - inspected and tested until the products have overcome all obstacles and meet our quality standards. Furthermore, it is important to us to take responsibility for our employees in China. We do this for example by building company housing and through our involvement in social and intercultural projects.



MORE THAN 20 YEARS OF EXPERTISE IN LIGHTING SOLUTIONS

When the two brothers Harald and Rainer Opolka from Solingen started out, they really didn't have much more than a garage, an old Atari computer, a set of tools, a drawing pad and around 1000 Deutschmarks of seed capital. Today, the former garage company of both the Ledlenser founders is an internationally operating company and one of the global market leaders in portable lights. The German Ledlenser brand conquered the flashlight market in the year 2000. The approach of equipping a flashlight with an LED instead of a bulb as a light source was absolutely visionary at that point in time. Millions of the “V8 Photon Pump” were sold worldwide and it constituted a new era of portable light – the “P7” achieved the same thing several years later.

To meet our objective as an LED pioneer, we are still using this technological advantage today in the development of new products – particularly in times during which LED lighting has become the norm in so many places and genuine quality is becoming harder and harder to recognize. At the same time, our premise “German Engineering & Design” has guided us from day one and justifies our unique commitment to quality. Ledlenser products give users worldwide the freedom of doing their jobs to the best of their ability or pursuing their passion with devotion – with the best possible light on their side.

LEDLENSER GUARANTEED QUALITY

7
YEAR
WARRANTY⁴



**GERMAN ENGINEERING
& DESIGN**



QUALITY

“German Engineering & Design” - this statement stands for the highest development and production standards in regard to technology, design, materials and workmanship. We hold more than 100 industrial property rights. These include patents, utility models and designs. We are proud of having received various design awards for our products.

WARRANTY

Since we are confident in the quality of our lights, we grant a seven-year warranty on nearly all products in connection with online registration. All original Ledlenser products covered by our warranty include a product registration card. To register, simply scan the QR code with a smartphone or enter the indicated URL on your laptop or PC.

ISO CERTIFICATION

We meet the requirements of the ISO 9001, ISO 14001 and ISO 50001 standards and are certified by TÜV Rheinland.

Quality management: DIN EN ISO 9001:2015

Our systematic quality management ensures a consistently high quality of our products and services. Clearly defined and comprehensible processes enable us to meet our customers' expectations consistently and professionally. We also meet the standard requirements at our Chinese location.

Environmental management: DIN EN ISO 14001:2015

Our company has defined an internal environmental policy and precise environmental objectives. Here, the focus is on the establishment and realization of an environmental management system, to ensure continuous improvements – e. g. in regard to CO₂ emissions, the use of resources and other environmental factors.

Energy management: DIN EN ISO 50001:2018

We operate energy management geared towards sustainability. This includes measures to reduce the consumption of energy such as electricity, gas and fuel as well as specific risk prevention.

¹⁻⁸ Information on page 76



NOTES

The information pertaining to package contents, appearance, performance, dimensions and weight corresponds to the information available at the time of publication. In the interest of product development, we reserve the right to change package contents, appearance, design and color without prior notice. Product images may vary from the actual products and may show optional accessories which can be purchased separately. Errors and misprints excepted.

1) Measurements according to ANSI FL1 on the respective setting. If no setting is explicitly indicated, the values refer to luminous flux (Lumen/lm) and beam distance (meters/m) on the highest setting and to the run time (hours/h) on the lowest setting. If the light is equipped with color LED(s), the measurements indicated apply to white light or white LED. A boost function (if applicable) can be used several times, but only for short periods of time. If the light has different energy modes, measurement is based on "energy saving mode."

2) Calculated capacity value in watt-hours (Wh) or milliampere hours (mAh). This applies to the delivery state of the battery/ies inside the respective item, or for lights with rechargeable battery/ies, to the rechargeable battery/ies inside the product when fully charged.

3) EP Patent 1880139; US Patent 7,461,960

4) Two year warranty from the date of purchase, or seven years with online registration through our website. The warranty applies worldwide; legal warranty rights also apply. It covers defects in material and manufacture. Battery packs are guaranteed to work correctly for 24 months. This warranty does not cover products in the "Solidline" series, the LiteWallet®, the Powercase, the Batterybox7, the Kidled-Series also the Ledlenser K-Serie (except K3), as well as defective batteries, holsters, pouches, remote switches, color filters, imprints and surface coatings. The warrantor is Ledlenser GmbH & Co. KG, Kronenstr. 5-7, 42699 Solingen, Germany. For more information visit ledlenser.com/warranty

5) The average charging time of the batteries in the delivery state in minutes may vary depending on the power supply unit used.

6) Additional talk time using the example of an iPhone X when charging with the fully charged batteries contained in the content of the article in question.

7) EP-Patent 3376097

8) The Bluetooth® word mark and logos are registered trademarks owned by Bluetooth SIG, Inc. and any use of these by Ledlenser GmbH & Co. KG is under license

You can find our terms and conditions at www.ledlenser.com

Ledlenser GmbH & Co. KG
Kronenstraße 5-7, 42699 Germany, Deutschland
USt-IdNr.: DE815242425, Amtsgericht Wuppertal, HRA 23078
Personally liable partner:
Ledlenser Beteiligungs GmbH
Headquarters: Solingen, Deutschland
Amtsgericht Wuppertal, HRB 24774
Executive Director: Michael Reuter, Kai Milewski

LEDLENSER WE'RE LOOKING FORWARD TO HEARING FROM YOU

We are always looking for ways to improve our support for you and your customers. We greatly appreciate any feedback you have on how we can build the Ledlenser brand together.

CONTACT MARKETING

Get answers to marketing questions and approval of marketing materials at:

CONTACT SALES GERMANY
vertrieb@ledlenser.com

CONTACT TECHNICAL SUPPORT

For uncomplicated and fast processing, please contact our Consumer Care Team for all services, product, warranty and goodwill questions.

Customers from Germany can reach us by e-mail: support@ledlenser.com

Customers from Belgium, the Netherlands and Luxembourg can reach us by e-mail: service.bnl@ledlenser.com

Customers from Austria can reach us by e-mail: support@ledlenser.at

Customers from Switzerland can reach us by e-mail: office@ledlenser.ch





ledlenser.com

Item no.502524



EN_V5.0_HLOS

A barcode is located in the bottom right corner. A thick red horizontal bar highlights a portion of the barcode.